

# SONAR V-STUDIO 100

## Hardware Manual

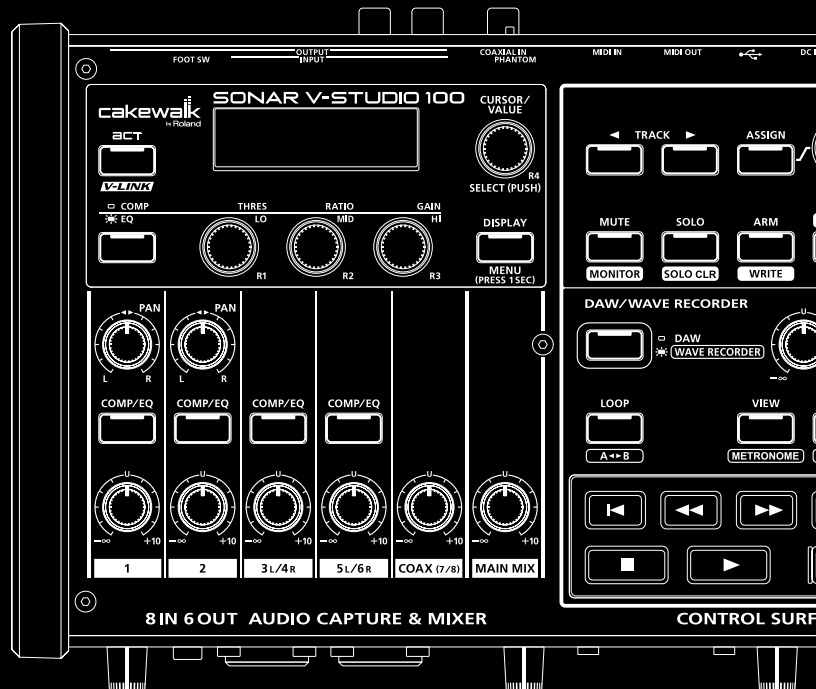



# USING THE UNIT SAFELY

## INSTRUCTIONS FOR THE PREVENTION OF FIRE, ELECTRIC SHOCK, OR INJURY TO PERSONS

### About ⚠ WARNING and ⚠ CAUTION Notices

<b>⚠ WARNING</b>	Used for instructions intended to alert the user to the risk of death or severe injury should the unit be used improperly.
<b>⚠ CAUTION</b>	Used for instructions intended to alert the user to the risk of injury or material damage should the unit be used improperly. * Material damage refers to damage or other adverse effects caused with respect to the home and all its furnishings, as well to domestic animals or pets.

### About the Symbols

	The ⚠ symbol alerts the user to important instructions or warnings. The specific meaning of the symbol is determined by the design contained within the triangle. In the case of the symbol at left, it is used for general cautions, warnings, or alerts to danger.
	The ⓧ symbol alerts the user to items that must never be carried out (are forbidden). The specific thing that must not be done is indicated by the design contained within the circle. In the case of the symbol at left, it means that the unit must never be disassembled.
	The ⚡ symbol alerts the user to things that must be carried out. The specific thing that must be done is indicated by the design contained within the circle. In the case of the symbol at left, it means that the power-cord plug must be unplugged from the outlet.

## ALWAYS OBSERVE THE FOLLOWING

### ⚠ WARNING

- Do not open (or modify in any way) the unit or its AC adaptor.



- Do not attempt to repair the unit, or replace parts within it (except when this manual provides specific instructions directing you to do so). Refer all servicing to your retailer, the nearest Roland Service Center, or an authorized Roland distributor, as listed on the "Information" page.



### ⚠ WARNING

- Never install the unit in any of the following locations.
  - Subject to temperature extremes (e.g., direct sunlight in an enclosed vehicle, near a heating duct, on top of heat-generating equipment); or are
  - Damp (e.g., baths, washrooms, on wet floors); or are
  - Exposed to steam or smoke; or are
  - Subject to salt exposure; or are
  - Humid; or are
  - Exposed to rain; or are
  - Dusty or sandy; or are
  - Subject to high levels of vibration and shakiness.



- Make sure you always have the unit placed so it is level and sure to remain stable. Never place it on stands that could wobble, or on inclined surfaces.



**⚠ WARNING**

- Be sure to use only the AC adaptor supplied with the unit. Also, make sure the line voltage at the installation matches the input voltage specified on the AC adaptor's body. Other AC adaptors may use a different polarity, or be designed for a different voltage, so their use could result in damage, malfunction, or electric shock.



- Use only the attached power-supply cord. Also, the supplied power cord must not be used with any other device.



- Do not excessively twist or bend the power cord, nor place heavy objects on it. Doing so can damage the cord, producing severed elements and short circuits. Damaged cords are fire and shock hazards!



- This unit, either alone or in combination with an amplifier and headphones or speakers, may be capable of producing sound levels that could cause permanent hearing loss. Do not operate for a long period of time at a high volume level, or at a level that is uncomfortable. If you experience any hearing loss or ringing in the ears, you should immediately stop using the unit, and consult an audiologist.



- Do not allow any objects (e.g., flammable material, coins, pins); or liquids of any kind (water, soft drinks, etc.) to penetrate the unit.



**⚠ WARNING**

- Immediately turn the power off, remove the AC adaptor from the outlet, and request servicing by your retailer, the nearest Roland Service Center, or an authorized Roland distributor, as listed on the "Information" page when:



- The AC adaptor, the power-supply cord, or the plug has been damaged; or
- If smoke or unusual odor occurs
- Objects have fallen into, or liquid has been spilled onto the unit; or
- The unit has been exposed to rain (or otherwise has become wet); or
- The unit does not appear to operate normally or exhibits a marked change in performance.

- In households with small children, an adult should provide supervision until the child is capable of following all the rules essential for the safe operation of the unit.



- Protect the unit from strong impact. (Do not drop it!)



- Do not force the unit's power-supply cord to share an outlet with an unreasonable number of other devices. Be especially careful when using extension cords—the total power used by all devices you have connected to the extension cord's outlet must never exceed the power rating (watts/amperes) for the extension cord. Excessive loads can cause the insulation on the cord to heat up and eventually melt through.



- Before using the unit in a foreign country, consult with your retailer, the nearest Roland Service Center, or an authorized Roland distributor, as listed on the "Information" page.



- DO NOT play a CD-ROM disc on a conventional audio CD player. The resulting sound may be of a level that could cause permanent hearing loss. Damage to speakers or other system components may result.



 **CAUTION**

- The unit and the AC adaptor should be located so their location or position does not interfere with their proper ventilation. 

---

- Always grasp only the plug on the AC adaptor cord when plugging into, or unplugging from, an outlet or this unit. 

---

- At regular intervals, you should unplug the AC adaptor and clean it by using a dry cloth to wipe all dust and other accumulations away from its prongs. Also, disconnect the power plug from the power outlet whenever the unit is to remain unused for an extended period of time. Any accumulation of dust between the power plug and the power outlet can result in poor insulation and lead to fire. 

---

- Try to prevent cords and cables from becoming entangled. Also, all cords and cables should be placed so they are out of the reach of children. 

---

- Never climb on top of, nor place heavy objects on the unit. 

---

- Never handle the AC adaptor or its plugs with wet hands when plugging into, or unplugging from, an outlet or this unit. 

---

- Before moving the unit, disconnect the AC adaptor and all cords coming from external devices. 

---

- Before cleaning the unit, turn off the power and unplug the AC adaptor from the outlet (p. 38). 

---

 **CAUTION**

- Whenever you suspect the possibility of lightning in your area, disconnect the AC adaptor from the outlet. 

---

  - Should you remove ground terminal screw, keep it in a safe place out of children's reach, so there is no chance of it being swallowed accidentally. 

---

  - Always turn the phantom power off when connecting any device other than condenser microphones that require phantom power. You risk causing damage if you mistakenly supply phantom power to dynamic microphones, audio playback devices, or other devices that don't require such power. Be sure to check the specifications of any microphone you intend to use by referring to the manual that came with it. 
- (This instrument's phantom power: 48 V DC, 5 mA maximum per channel.)
-

# IMPORTANT NOTES

## Power Supply

- Do not connect this unit to same electrical outlet that is being used by an electrical appliance that is controlled by an inverter (such as a refrigerator, washing machine, microwave oven, or air conditioner), or that contains a motor. Depending on the way in which the electrical appliance is used, power supply noise may cause this unit to malfunction or may produce audible noise. If it is not practical to use a separate electrical outlet, connect a power supply noise filter between this unit and the electrical outlet.
- The AC adaptor will begin to generate heat after long hours of consecutive use. This is normal, and is not a cause for concern.
- Before connecting this unit to other devices, turn off the power to all units. This will help prevent malfunctions and/or damage to speakers or other devices.

## Placement

- Using the unit near power amplifiers (or other equipment containing large power transformers) may induce hum. To alleviate the problem, change the orientation of this unit; or move it farther away from the source of interference.
- This device may interfere with radio and television reception. Do not use this device in the vicinity of such receivers.
- Noise may be produced if wireless communications devices, such as cell phones, are operated in the vicinity of this unit. Such noise could occur when receiving or initiating a call, or while conversing. Should you experience such problems, you should relocate such wireless devices so they are at a greater distance from this unit, or switch them off.
- Do not expose the unit to direct sunlight, place it near devices that radiate heat, leave it inside an enclosed vehicle, or otherwise subject it to temperature extremes. Excessive heat can deform or discolor the unit.
- When moved from one location to another where the temperature and/or humidity is very different, water droplets (condensation) may form inside the unit. Damage or malfunction may result if you attempt to use the unit in this condition. Therefore, before using the unit, you must allow it to stand for several hours, until the condensation has completely evaporated.

- Depending on the material and temperature of the surface on which you place the unit, its rubber feet may discolor or mar the surface.  
You can place a piece of felt or cloth under the rubber feet to prevent this from happening. If you do so, please make sure that the unit will not slip or move accidentally.

## Maintenance

- For everyday cleaning wipe the unit with a soft, dry cloth or one that has been slightly dampened with water. To remove stubborn dirt, use a cloth impregnated with a mild, non-abrasive detergent. Afterwards, be sure to wipe the unit thoroughly with a soft, dry cloth.
- Never use benzine, thinners, alcohol or solvents of any kind, to avoid the possibility of discoloration and/or deformation.

## Handling CD-ROMs

- Avoid touching or scratching the shiny underside (encoded surface) of the disc. Damaged or dirty CD-ROM discs may not be read properly. Keep your discs clean using a commercially available CD cleaner.

## Using SD Memory Cards

- Carefully insert the SD memory card all the way in—until it is firmly in place.

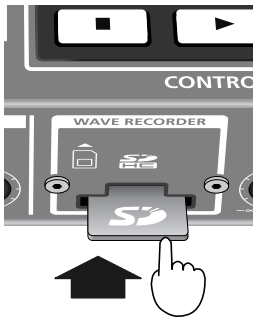

- Never touch the terminals of the SD memory card. Also, avoid getting the terminals dirty.
- SD memory cards are constructed using precision components; handle the cards carefully, paying particular note to the following.
  - To prevent damage to the cards from static electricity, be sure to discharge any static electricity from your own body before handling the cards.
  - Do not touch or allow metal to come into contact with the contact portion of the cards.
  - Do not bend, drop, or subject cards to strong shock or vibration.
  - Do not keep cards in direct sunlight, in closed vehicles, or other such locations (storage temperature: -25 to 85C).
  - Do not allow cards to become wet.
  - Do not disassemble or modify the cards.

## Copyright

- Recording, duplication, distribution, sale, lease, performance, or broadcast of copyrighted material (musical works, visual works, broadcasts, live performances, etc.) belonging to a third party in part or in whole without the permission of the copyright owner is forbidden by law.
- This product can be used to record or duplicate audio or visual material without being limited by certain technological copy-protection measures. This is due to the fact that this product is intended to be used for the purpose of producing original music or video material, and is therefore designed so that material that does not infringe copyrights belonging to others (for example, your own original works) can be recorded or duplicated freely.
- Do not use this unit for purposes that could infringe on a copyright held by a third party. We assume no responsibility whatsoever with regard to any infringements of third-party copyrights arising through your use of this unit.

## Additional Precautions

- Use a reasonable amount of care when using the unit's buttons, sliders, or other controls; and when using its jacks and connectors. Rough handling can lead to malfunctions.
- Never strike or apply strong pressure to the display.
- When connecting / disconnecting all cables, grasp the connector itself—never pull on the cable. This way you will avoid causing shorts, or damage to the cable's internal elements.
- To avoid disturbing your neighbors, try to keep the unit's volume at reasonable levels. You may prefer to use headphones, so you do not need to be concerned about those around you (especially when it is late at night).
- When you need to transport the unit, package it in the box (including padding) that it came in, if possible. Otherwise, you will need to use equivalent packaging materials.
- Some connection cables contain resistors. Do not use cables that incorporate resistors for connecting to this unit. The use of such cables can cause the sound level to be extremely low, or impossible to hear. For information on cable specifications, contact the manufacturer of the cable.

# Contents

---

USING THE UNIT SAFELY .....	3
IMPORTANT NOTES .....	6

## Overview ..... 11

---

Overview of the SONAR V-STUDIO 100 .....	12
Panel Descriptions .....	14
Input/output component.....	14
Front panel.....	14
Rear panel.....	15
Digital mixer component .....	17
Input section.....	17
System section.....	18
Using the control surface component.....	19
Control surface screen .....	19
Channel strip section.....	20
Transport section .....	22
ACT section .....	23
VS-100 properties page .....	24
Using DAW software other than SONAR.....	24

## WAVE Recorder..... 25

---

Using the WAVE recorder .....	26
WAVE recorder screen .....	26
Basic operation.....	27
SD memory card .....	28
Recording .....	29
Playing back a file.....	30
Selecting a file to play back.....	30
Viewing file information.....	31
Inserting markers .....	32
Loop playback (A-B REPEAT).....	33
Using the metronome .....	34
Recording while playing back a file .....	35
Deleting a file.....	36



---

## Connections..... 37

---

Connections .....	38
Connecting the AC adaptor.....	38
Connecting computers and audio equipments.....	39
Turning the power on.....	40
Connections and signal flow.....	41
Connecting microphones and guitars.....	41
Connecting audio equipment and synthesizers.....	43
Connecting footswitches .....	46

## Compressor and Equalizer..... 47

---

Using the compressors and equalizers.....	48
Turning on the compressors and equalizers.....	48
Turning off the compressors and equalizers .....	48
Setting the compressors and equalizers.....	49
Setting the equalizers.....	49
Setting the compressors.....	50

## Appendix ..... 51

---

System settings.....	52
Formatting an SD memory card .....	52
Sampling frequency setting .....	52
Reverb settings.....	53
Initialization.....	53
Initializing the settings.....	53
Initializing the system settings (Factory Reset).....	54
Other settings.....	54
Operations in the system setting screen.....	54
Parameter list .....	55
Block Diagram .....	56
About V-LINK.....	57
Error Message List .....	58
Specifications.....	60
Index .....	62
Information.....	67

---

**Before using this unit, carefully read the sections entitled: "USING THE UNIT SAFELY" and "IMPORTANT NOTES" (Hardware manual p. 3; p. 6). These sections provide important information concerning the proper operation of the unit. Additionally, in order to feel assured that you have gained a good grasp of every feature provided by your new unit, Hardware manual and Getting started should be read in its entirety. The manual should be saved and kept on hand as a convenient reference.**

**Copyright © 2009 ROLAND CORPORATION**

**All rights reserved. No part of this publication may be reproduced in any form without the written permission of ROLAND CORPORATION.**

- \* Use of the demo song supplied with this product for any purpose other than private, personal enjoyment without the permission of the copyright holder is prohibited by law. Additionally, this data must not be copied, nor used in a secondary copyrighted work without the permission of the copyright holder.
- \* The explanations in this manual include illustrations that depict what should typically be shown by the display. Note, however, that your unit may incorporate a newer, enhanced version of the system (e.g., includes newer sounds), so what you actually see in the display may not always match what appears in the manual.
- \* Cakewalk is a registered trademark of Cakewalk Inc.
- \* Microsoft, Windows and Windows Vista are registered trademarks of Microsoft Corporation.
- \* The screen shots in this document are used in compliance with the guidelines of the Microsoft Corporation.
- \* Windows® is known officially as: "Microsoft® Windows® operating system."
- \* Apple, Macintosh and Mac OS are registered trademarks of Apple Inc.
- \* Pentium is a registered trademark of Intel Corporation.
- \* VST is a trademark of Steinberg Media Technologies AG.
- \* All product names mentioned in this document are trademarks or registered trademarks of their respective owners.
- \* MMP (Moore Microprocessor Portfolio) refers to a patent portfolio concerned with microprocessor architecture, which was developed by Technology Properties Limited (TPL). Roland has licensed this technology from the TPL Group.

# Overview

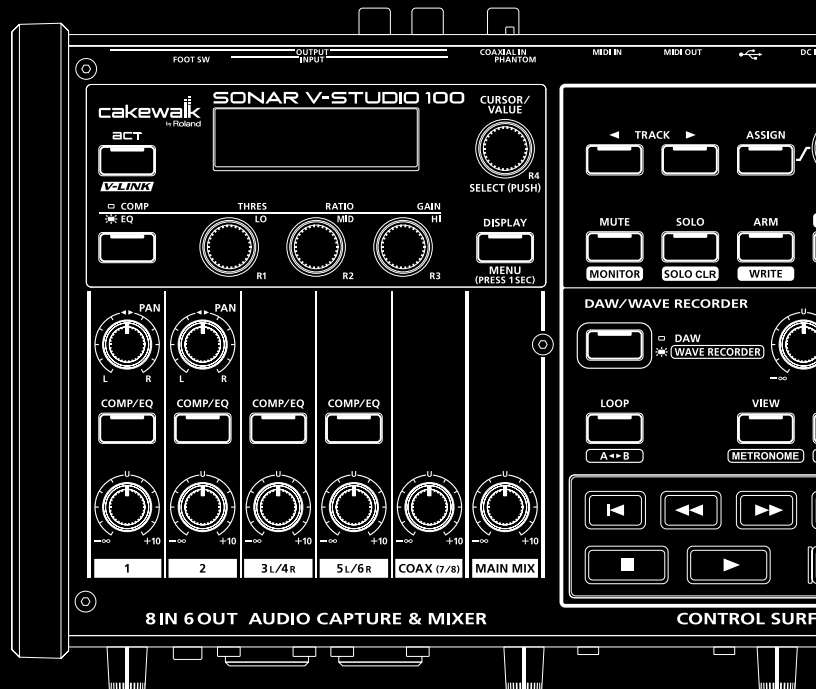

# Overview of the SONAR V-STUDIO 100



## High-end spec audio interface functions

- USB 2.0 audio interface supporting 8-in/6-out and 24-bit/96 kHz
- Extraneous noise-resistant balanced input/output
- Two XLR input jacks with microphone preamps and phantom power
- Carefully selected parts are used to ensure transparent sound, ensuring spacious and high-quality recordings
- Equipped with a wide variety of input/output terminals that provide connective compatibility with any equipment. High-impedance (Hi-Z) terminals for directly connecting guitars or basses
- Both MIDI input/output and digital input terminals packed onto the compact body
- Low latency driver supporting WDM/ASIO 2.0

## Compact control surface

### Connection with SONAR provides a comfortable editing environment

- Equipped with a 100 mm motor fader
- Touch-sensitive capability-smooth operation with great precision
- Equipped with an assignable encoder and a multitude of buttons
- Intuitive control of mixing parameters with visual feedback on the main unit's LCD screen
- Can be used as a physical controller for other software such as Logic



## A digital mixer that supports a range of inputs

- A digital mixer with 8 channel input
- High quality sound design through digital signal processing with internal 40-bit computing
- A compressor and a 3-band parametric equalizer for analog input

## WAVE recorder function

- Directly record sample or performance onto an SD card  
Connecting to a computer is not necessary. The SONAR V-STUDIO 100 can be used as a standalone WAVE recorder.
- Digital recording at up to 24-bit/96kHz
- \* The WAVE recorder function is available only when the SONAR V-STUDIO 100 is not connected to a computer via USB.

# Panel Descriptions

## Input/output component

### Front panel

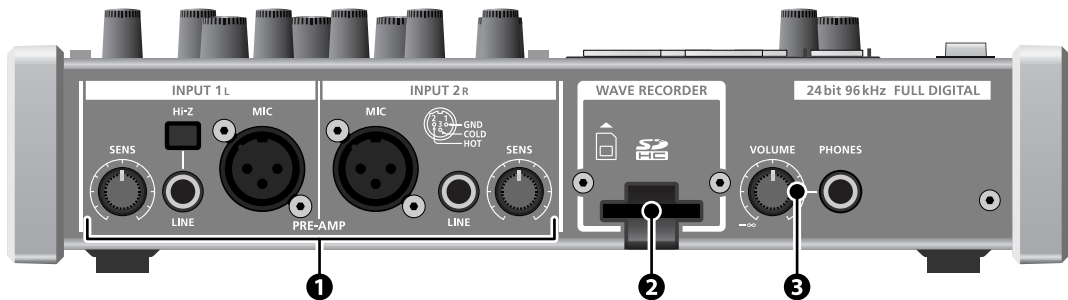

#### 1. INPUT 1L/INPUT 2R

Analog audio signal input jacks with a microphone preamp. You can use the [SENS] knob to adjust the input level of INPUT 1L/INPUT 2R. The level is displayed on the screen. (See p. 18.) These inputs correspond to input 1-2 in the USB audio interface function.

##### **MIC (XLR balanced input)**

This input supports a 48 V phantom power supply and is compatible with condenser microphones that support a phantom power supply. If using a phantom-compatible microphone, turn on the phantom power supply switch. (See p. 16.)

##### **LINE (1/4" TRS balanced input)**

TRS balanced type line input terminal. The INPUT 1L jack supports high-impedance input. If you connect a guitar, turn on the [Hi-Z] button. You can also connect an unbalanced plug to this input.

#### **[Hi-Z] button**

This switch changes the input impedance. Set this switch as appropriate for the device that you've connected to the INPUT 1L LINE jack. If you've connected a guitar or bass, press this switch inward to turn it on. If nothing is connected, leave this switch in the off position. The [Hi-Z] button affects only the LINE jack of INPUT 1L. It does not change the impedance of the MIC jack for INPUT 1L, nor of the LINE jack of INPUT 2R.

#### 2. SD card slot

Insert an SD card for the WAVE recorder here. For more information, see p. 28.

#### 3. Headphone output

This output delivers the same signal as the MAIN output. To adjust the headphone volume, use the [VOLUME] knob.

Rear panel

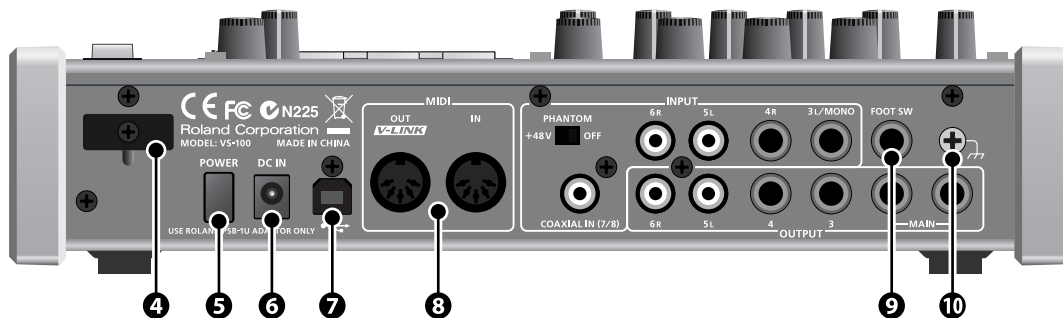

**4. Cord hook**

Hook the AC adaptor's cord here, see p. 38.

**5. Power switch**

Turn the power on/off. For more information, see p. 40.

**6. DC IN jack**

Connect the DC plug of the supplied AC adaptor here.

**7. USB connector**

Use a USB cable to connect the V-STUDIO 100 to a personal computer.

**8. MIDI connectors (MIDI OUT/V-LINK and MIDI IN)**

When the SONAR V-STUDIO 100 is connected to a computer, these connectors work as 1 in/1 out USB MIDI interfaces.

When the SONAR V-STUDIO 100 is not connected to a computer, the MIDI OUT connector becomes a MIDI output connector for V-LINK.

**9. Footswitch connector**

Connect a footswitch (sold separately) here.

You can use a footswitch to control the WAVE recorder function or start and stop SONAR VS.

For more information about footswitch, see "Connecting footswitches" (p. 46).

**10. Grounding terminal**

Depending on the circumstances of a particular setup, you may experience a discomforting sensation, or perceive that the surface feels gritty to the touch when you touch this device, microphones connected to it, or the metal portions of other objects, such as guitars. This is due to an infinitesimal electrical charge, which is absolutely harmless. However, if you are concerned about this, connect the ground terminal (see figure) with an external ground. When the unit is grounded, a slight hum may occur, depending on the particulars of your installation. If you are unsure of the connection method, contact the nearest Roland Service Center, or an authorized Roland distributor, as listed on the "Information" page.

Unsuitable places for connection

- Water pipes (may result in shock or electrocution)
- Gas pipes (may result in fire or explosion)
- Telephone-line ground or lightning rod (may be dangerous in the event of lightning)

\* This product is equipped with balanced (XLR/TRS) type jacks. Wiring diagrams for these jacks are shown below. Make connections after first checking the wiring diagrams of other equipment you intend to connect.

## INPUT

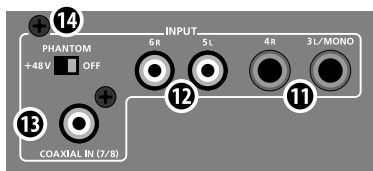

### 11. INPUT 3L/MONO and 4R (1/4" TRS balanced input)

Analog audio signal input jacks for line input. If you only plug into one INPUT 3L/MONO jack, it will function as a mono input.

These inputs correspond to input 3-4 in the USB audio interface function.

### 12. INPUT 5L and 6R (RCA pin input)

Analog audio signal input jacks for line input. These inputs correspond to input 5-6 in the USB audio interface function.

### 13. COAXIAL IN (7/8) (coaxial digital input)

A digital input terminal that supports S/PDIF.

This terminal supports 24-bit/96kHz digital signals.

These inputs correspond to input 7-8 in the USB audio interface function.

- \* If you connect the SONAR V-STUDIO 100 to a computer, you must match the sampling frequency of the input signal to that of the SONAR V-STUDIO 100. For more information about setting the sampling frequency, see **"Sampling frequency setting"** (p. 52).

### 14. Phantom power switch

This switch supplies phantom power to the INPUT 1L and INPUT 2R XLR terminals.

- \* You must only turn on this switch if connecting a microphone that needs phantom power. Supplying phantom power to dynamic microphones or audio reproducing equipment may cause a failure. For more information about the specifications of your microphone, see its manual.
- \* Phantom power supply of SONAR V-STUDIO 100: DC 48 V, 5 mA maximum per channel

## OUTPUT

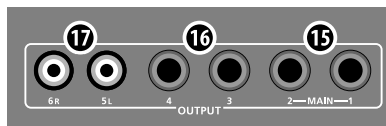

### 15. MAIN OUTPUT 1 and 2 (1/4" TRS balanced output)

Analog audio signal output jacks

These outputs deliver the signals of the MAIN MIX, WAVE recorder and USB audio playback (OUT 1/2) from the mixer.

### 16. OUTPUT 3 and 4 (1/4" TRS balanced output)

Analog audio signal output jacks.

These outputs deliver the signal from USB audio OUT 3/4.

### 17. OUTPUT 5L and 6R (RCA pin output jack)

Analog audio signal output jacks

These outputs deliver the signal from the USB audio OUT 5/6.

## [PLAYBACK] knob



Use this knob to adjust the volume of the USB audio playback (OUT 1/2) that is output from the MAIN OUTPUT 1/2 and the headphone terminal.



## Digital mixer component



## Input section

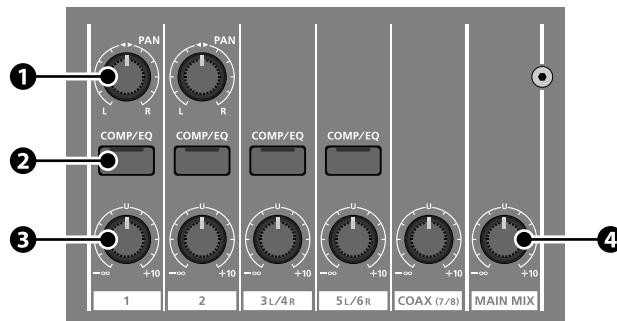

### 1. [PAN] knob (INPUT 1L/INPUT 2R)

Use this knob to adjust the balance between the right and left channels of the signal that is input from the INPUT 1L/2R.

### 2. [COMP/EQ] button

Use this button to turn the compressors and equalizers on and off for each channel. For more information, see **“Using the compressors and equalizers”** (p. 48).

### 3. Level knob

Use this knob to adjust the mixing level for each channel.

### 4. [MAIN MIX] knob

Use this knob to adjust the main volume after mixing.

## System section

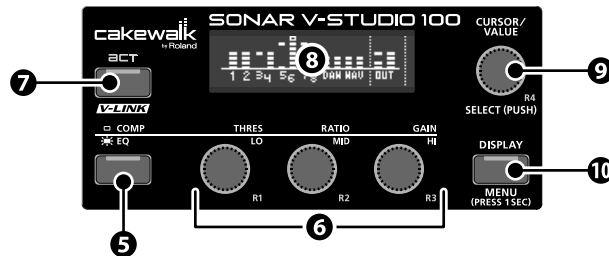

### 5. Compressor/equalizer setting button

Use this button to switch the display on the setting screen between the compressor and the equalizer when using these effects.

For more information about using the compressors and equalizers, see *“Using the compressors and equalizers”* (p. 48).

### 6. [THRES/LO]/[R1] knob, [RATIO/MID]/[R2] knob and [GAIN/HI]/[R3] knob

The functions of these knobs depend on the status of the SONAR V-STUDIO 100.

- When the equalizer setting screen is displayed  
Use these knobs to change each parameter of the equalizer. (See *“Setting the equalizers”* (p. 49).)
- When the compressor setting screen is displayed  
Use these knobs to change each parameter of the compressor. (See *“Setting the compressors”* (p. 50))
- When the ACT function is on (only when SONAR is in use: see *“ACT section”* (p. 23))  
Use these knobs to control the plug-ins for SONAR and the ACT function.

### 7. [ACT]/[V-LINK] button

When you are using SONAR, this button is the [ACT] button. When you press this button, it lights up and you can use the [R1]–[R4] knobs to control the plug-ins for SONAR and the ACT function.

If SONAR V-STUDIO 100 is not connected to a computer, this button becomes the [V-LINK] button. (See p. 57)

### 8. Display screen

This screen displays a range of information. When you press the [DISPLAY] button, the level meter screen is displayed.

#### Level meter screen

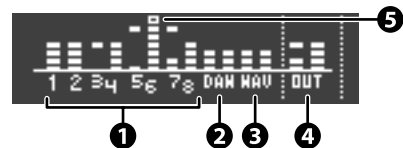

#### 1. The input level of each INPUT

INPUT 1/2 shows the level after the signal passes through the [SENS] knob.

#### 2. USB audio (OUT 1/2) playback level

#### 3. WAVE recorder playback level

#### 4. MAIN OUT 1/2 output level

#### 5. Peak indicator

Use the level knobs to adjust each level to ensure this peak indicator is not lit.

### 9. [CURSOR/VALUE]/[R4] knob

Use this knob to move the cursor on the display or change the value of the parameter. Push the knob ([SELECT] button) to fix the value.

When the ACT function is on, this knob controls the plug-ins for SONAR and the ACT function.

### 10. [DISPLAY] button

Press this button to display the level meter screen.

Press and hold the [DISPLAY] button for about 1 second to display the system screen. On this screen you can change the system settings of SONAR V-STUDIO 100. For more information, see p. 52.

## Using the control surface component

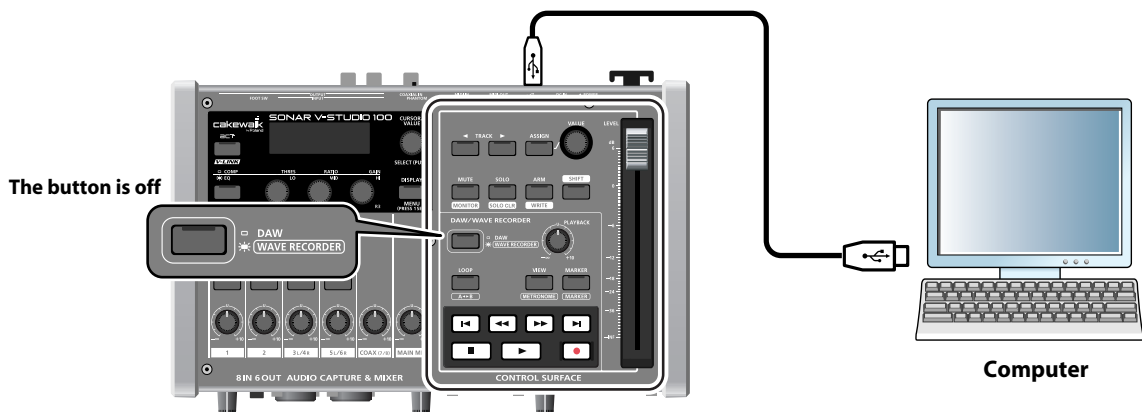

If you connect SONAR V-STUDIO 100 to a computer and turn the power on, the section within the bounding rectangle in this illustration functions as the control surface for SONAR VS.

## Control surface screen

### Level meter screen



### Control surface screen

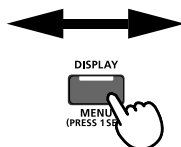

When you are using SONAR, pressing the [DISPLAY] button switches between the level meter screen and the control surface screen. The control surface screen displays information about SONAR and plug-ins that can be controlled from SONAR V-STUDIO 100.

### Control surface screen

1. Name of the parameter controlled by the [R1]–[R4] knobs  
When the ACT function is on, turning the [R1]–[R4] knobs switches the display to show the name of the parameter that is currently being manipulated.
2. Name of the plug-in controlled by the [R1]–[R4] knobs
3. Items (track or bus) that can be controlled in the channel strip section
4. Name of the track or bus currently being controlled in the channel strip section
5. Name of the parameter assigned to the [VALUE] knob
6. Value of the parameter assigned to the [VALUE] knob

## Channel strip section

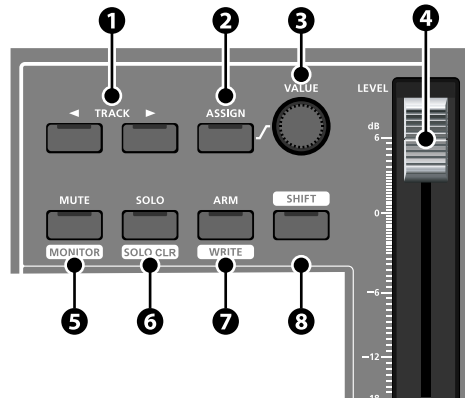

This section controls SONAR's track or bus parameters.

### 1. Track selection button

Use this button to select the track (or bus) to control.

#### [SHIFT] + track selection buttons

Press this key combination to switch the current strip between the track and the bus.

#### Track selection button + [VALUE] knob

Press and hold the track selection button while you turn the [VALUE] knob to select the track to control.

### 2. [ASSIGN] button

Press this button to switch the parameter assigned to the [VALUE] knob.

#### MEMO

The assigned parameter will depend on the track (or bus) you're controlling. For details, refer to SONAR's online Help.

#### MEMO

The currently assigned parameter is displayed on the screen. (See p. 19.)

#### [SHIFT] + [ASSIGN] buttons

When you press this key combination, the [ASSIGN] button flashes and you can use the [VALUE] knob to change the current time (jog/shuttle mode).

To restore the display, press the [ASSIGN] button.

### 3. [VALUE] knob

Use this knob to change the value of the current parameter.

---

#### 4. Channel fader

Use this to control the volume of the current strip.

The channel fader has a touch-sensitive motor fader so it can move in response to the volume of the current strip. It also moves while playing, according to the automation information.

To record automation information, touch and then release the fader during automation recording.

##### **MEMO**

The motor fader moves very quietly. However, you may want to make it totally silent if you plan to record with microphones or mix any soft music. To stop the operation of the motor fader, turn on “Disable Fader Movement” in the VS-100 properties page. For more information about the VS-100 properties page, see “**VS-100 properties page**” (p. 24).

##### **cf.**

For more information about recording automation information, see the SONAR online Help.

#### 5. [MUTE] button

Press this button to turn the mute on or off for the current strip.

When the current strip is muted, the [MUTE] button is lit.

##### **[SHIFT] + [MUTE] buttons**

Use this key combination to turn the input monitor on and off for the current strip.

\* When the current strip is the bus, this does not work.

#### 6. [SOLO] button

Press this button to turn the solo on or off for the current strip.

When the current strip is the solo, the [SOLO] button is lit.

##### **[SHIFT] + [SOLO] buttons**

Use this key combination to turn the solo on or off for all tracks.

#### 7. [ARM] button

Press this button to turn recording standby on or off for the current strip.

When the current strip is in recording standby mode, the [ARM] button is lit.

\* When the current strip is the bus, this does not work.

##### **[SHIFT] + [ARM] buttons**

Use this key combination to bring the current strip to automation recording standby mode.

##### **cf.**

For more information about recording automation information, see the separate SONAR online Help.

#### 8. [SHIFT] button

Use this button in combination with other buttons.

## Transport section

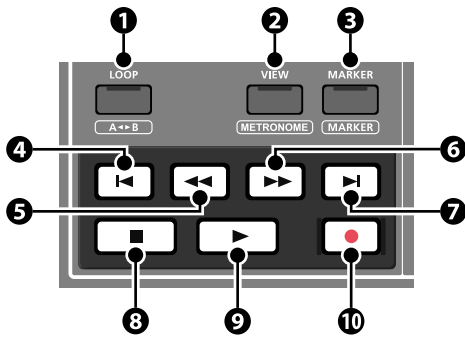

This section controls playback of SONAR.

### 1. [LOOP] button

Press this button to turn SONAR's loop function on or off.

\* This button is not lit even when SONAR's loop function is on.

#### [SHIFT] + [LOOP] buttons

Use this key combination to set the selected range for SONAR's loop function.

\* For more information about selecting the range, see the separate SONAR online help.

### 2. [VIEW] button

Press this button to display SONAR's Track view.

#### [SHIFT] + [VIEW] buttons

Use this key combination to display SONAR's Console view.

### 3. [MARKER] button

Press this button to insert a marker at the current time.

\* If you press this button while SONAR is paused, the Marker view is displayed.

### 4. [Left Arrow] Button

Press this button to move the current time to the beginning of the project.

#### [SHIFT] + [Left Arrow] button

Use this key combination to move the current time to the previous marker.

### 5. [Double Left Arrow] Button

Press this button to rewind the current time.

#### [SHIFT] + [Double Left Arrow] button

Use this key combination to move the current time to the previous measure.

### 6. [Double Right Arrow] Button

Press this button to fast-forward the current time.

#### [SHIFT] + [Double Right Arrow] button

Use this key combination to move the current time to the next measure.

### 7. [Right Arrow with Vertical Bar] Button

Press this button to move the current time to the end of the project.

#### [SHIFT] + [Right Arrow with Vertical Bar] button

Use this key combination to move the current time to the next marker.

### 8. [Square] Button

Press this button to stop the transport.

### 9. [Right Arrow] Button

Press this button to start playback.

If you press this button during playback, the playback pauses.

### 10. [Red Circle] Button

Press this button to start recording tracks that are in recording standby mode.

If you press this button during playback, you can start recording tracks that are in recording standby mode without stopping playback.

## ACT section



When you press the [ACT] button to turn on the ACT function, the button lights up and you can use the [R1]–[R4] knobs to control the parameters of plug-ins that support the ACT function.

### NOTE

You cannot control plug-ins that do not support the ACT function.

You can configure the parameters controlled by the four knobs in the VS-100 properties page.

## What is ACT?

ACT (Active Controller Technology) is a function for controlling SONAR from external devices such as MIDI controllers or control surfaces. Plug-in effects and synthesizers that are active on SONAR are controlled automatically.

For more information, see the SONAR online Help.

## Expanded ACT section

If you turn on the system setting “DAW Full Asgn,” you’ll be able to use not only the four knobs of the ACT section but also the buttons and knobs of the **“Input section”** (p. 17) to control ACT-compatible plug-ins. The names of the parameters being controlled are shown in the **“VS-100 properties page”** (p. 24). For details on how to turn on the system setting “DAW Full Asgn,” refer to **“System settings”** (p. 52).

### NOTE

If “DAW Full Asgn” is turned on, you won’t be able to use the input section to control SONAR V-STUDIO 100’s digital mixer functionality. If you want to adjust the mixer, you’ll need to turn “DAW Full Asgn” off.

## VS-100 properties page

The VS-100 properties page displays the names of the parameters that can be controlled with the [R1]–[R4] knobs.

You can also configure the action of the footswitches or of the motor fader connected to SONAR V-STUDIO 100.

To display the VS-100 properties page, in SONAR, select “VS-100” command from “Tools” menu.

When the VS-100 properties page is displayed, pressing the [F1] key on your computer displays the online Help. For more information about the VS-100 properties page, see the online Help.



## Using DAW software other than SONAR

If you set the system setting “**DAW Select**” (p. 55) to “Other,” the SONAR V-STUDIO 100 will be recognized as a Mackie Control from your DAW software, and you’ll be able to use the controllers enclosed by the frame in the illustration to control your DAW software.



### MEMO

By default, no function is assigned to the , , [VIEW], and [MARKER] buttons. Use the assign function of your DAW software to assign the desired function to these buttons.

### MEMO

For details on how to make settings in your DAW, refer to the documentation for your DAW.

### MEMO

For DAW software other than SONAR, you won’t be able to turn on the [ACT] button.

### MEMO

For details on making system settings, refer to “**System settings**” (p. 52).



# WAVE Recorder

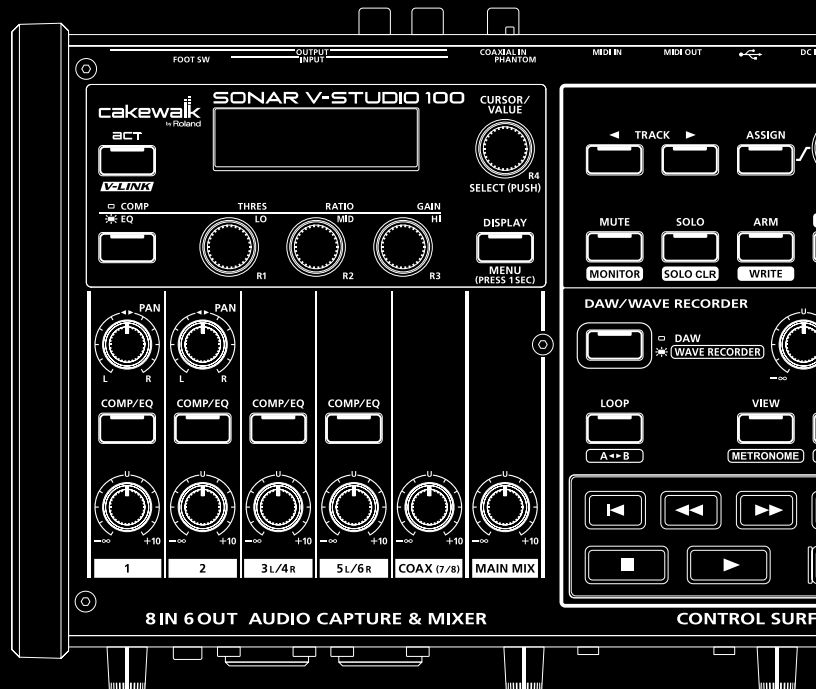

# Using the WAVE recorder

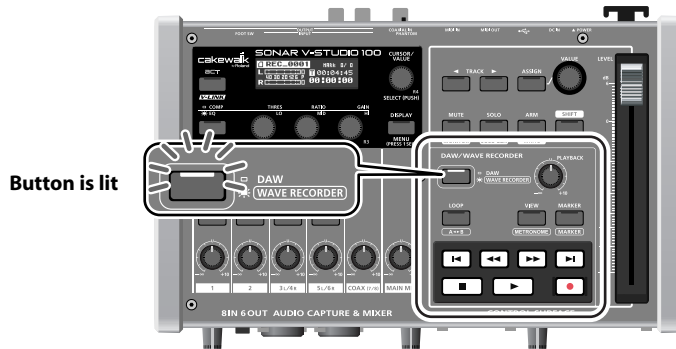

When you turn on the power of the SONAR V-STUDIO 100 without connecting it to a computer, the [DAW/WAVE RECORDER] button lights up and you can operate the WAVE recorder.

You can use the WAVE recorder to record signals that have been mixed in the digital mixer section.

### MEMO

If you change the system setting “WAV-Rec Source,” you can also use the WAVE recorder to record only the signals input to INPUT 1L/INPUT 2R. For more information, see “Parameter list” (p. 55).

### MEMO

Playback sound from the WAVE recorder is output via the MAIN OUTPUT 1/2 and the headphones.

## WAVE recorder screen

### Main screen:

The main screen of the WAVE recorder. When you turn the power on and press the [DAW/WAVE RECORDER] button, this screen is displayed. This is where you record and playback songs.

### Main screen



### Finder screen:

Use this screen to perform operations such as listing, selecting or deleting files.

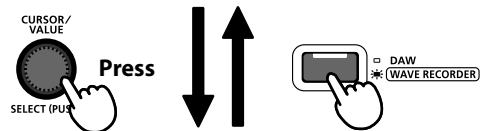

### MEMO

If a different screen is displayed, pressing the [DAW/WAVE RECORDER] button will return you to the main screen.

### Finder screen

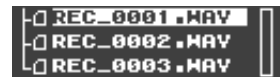

### NOTE

If the SONAR V-STUDIO 100 is connected via USB to your computer, pressing the [DAW/WAVE RECORDER] button will not access the WAVE recorder main screen.

## Information displayed on the main screen

1. File name
2. Level meter
  - Displays the output level
  - When input signal was detected, displays the input level
3. Marker view
  - Number on the left: the number of the marker that was passed at the point displayed on the time counter
  - Number on the right: the number of markers contained in the file
4. File length:
  - while recording, this displays the remaining recording time
5. Time counter
  - During playback and while paused: displays elapsed time since the beginning of the file
  - During recording: displays elapsed recording time



## Basic operation

1. Display the main screen
2. Adjust the output level of the WAVE recorder
3. [A<>B] (repeat A-B) button
 

Play back the section between two points (A-B) in the file repeatedly.

Set the A and B marks during playback to repeat the section between A and B.

For more information, see “**Loop playback (A-B REPEAT)**” (p. 33).
4. [METRONOME] button
 

Turn on the metronome. For more information, see “**Using the metronome**” (p. 34).
5. [MARKER] button
 

Insert a marker at the point displayed on the time counter.
6. Reset the time counter to zero
 

If markers have been inserted, pressing this button will reset the time counter to the point of the previous marker.
7. Rewind the time counter
8. Fast-forward the time counter
9. Move the time counter to the end of the file
 

If markers have been inserted, pressing this button will move the time counter to the point of the next marker.
10. Stop
11. Start the playback from the point displayed on the time counter
12. Create a new file and start recording

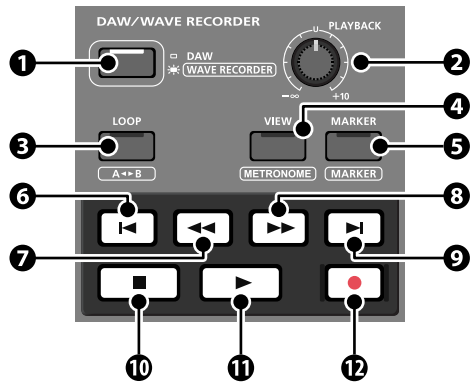

## SD memory card

**MEMO**

In SONAR V-STUDIO 100, data is recorded on an SD memory card.

### Inserting an SD memory card

**NOTE**

NEVER insert or remove an SD memory card when the power of SONAR V-STUDIO 100 is on. Doing so may result in the loss of data from the SONAR V-STUDIO 100 or the SD memory card.

**1. Turn the power off.**

**2. Insert the SD card into the SD card slot.**

- Never insert or remove an SD memory card while this unit's power is on. Doing so may corrupt the unit's data or the data on the SD memory card.
- Carefully insert the SD memory card all the way in—until it is firmly in place.

**3. Turn the power on.**

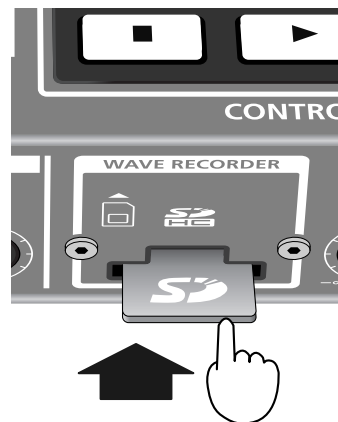

### Removing an SD memory card

**1. Turn the power off.**

**2. Push the memory card forward lightly and release your finger.**

The memory card will pop out slightly. Pull the card out.

### Formatting an SD memory card

If you use a new SD memory card, or if you use an SD memory card that has been used in other devices such as personal computers, the card will need to be formatted before it can be used for the SONAR V-STUDIO 100.

**cf.**

"Formatting an SD memory card" (p. 52)

## Recording

### 1. Check the input level.

If the peak indicator at the right end of the level meter (indicated by the arrow in the illustration) is lit, turn the [MAIN MIX] knob to the left to reduce the level.

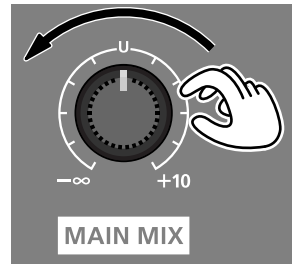
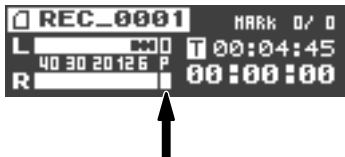

### 2. Press the (Record) button and start recording.

The time counter starts counting forward.

### 3. Press the (Stop) button to stop recording.

#### **MEMO**

The recorded file will automatically be given a name of "REC\_\*\*\*\*.WAV". The "\*\*\*\*" field will be a number that starts with 0001 and increments each time you record.

#### **MEMO**

The recorded file is saved in the root folder of the SD memory card.

## Playing back a file

1. Press the  (Playback) button.
2. Use the [PLAYBACK] knob to adjust the playback volume.

### NOTE

If the sampling frequency of the file being played differs from the sampling frequency setting of the SONAR V-STUDIO 100, you may hear a small amount of noise when the file is playing or stopped. In this case, refer to “Sampling frequency setting” (p. 52) and set the SONAR V-STUDIO 100’s sampling frequency to match the sampling frequency of the file you’re playing.

## Selecting a file to play back

### MEMO

The SONAR V-STUDIO 100 cannot play back files that are inside a folder. When using a computer to copy files for playback to SD memory, you must copy them to the root folder.

1. In the main screen, press the [CURSOR/VALUE] knob to open the finder screen (p. 26).
2. In the finder screen, turn the [CURSOR/VALUE] knob to select the file that you want to play back.

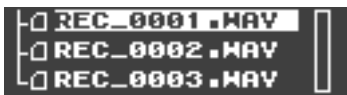

3. In the next screen, ensure that “Select” is highlighted and press the [CURSOR/VALUE] knob.



## Viewing file information

The finder screen lets you view the file size and file format.

1. From the main screen, press the [CURSOR/VALUE] knob to open the finder screen (p. 26).
2. In the finder screen, turn the [CURSOR/VALUE] knob to select the desired file, and then press the [CURSOR/VALUE] knob.
3. Turn the [CURSOR/VALUE] knob to highlight "Information," and then press the [CURSOR/VALUE] knob.



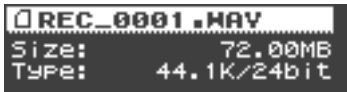

4. The display will show the file size and the file format (sample rate and bit depth).



5. Press the [DISPLAY] button to return to the previous screen.

## Inserting markers

During playback or recording, you can insert markers at any point on the file.

By inserting markers on a file, you can quickly jump to those positions by pressing the  button or  button.

- 1. Play back the file.**
- 2. When the file reaches the point where you want to insert a mark, press the [MARKER] button.**

The number displayed in the marker counter increases.



## Deleting a marker

---

During playback or recording, you can hold down the [SHIFT] button and press the [MARKER] button to delete the preceding marker.



## Loop playback (A-B REPEAT)

This function allows you to play back any section (A-B) in the file repeatedly. After inserting marks A and B while the file is playing you can then repeat the section between the two marks.

### 1. Play back the file.

Press the [A <> B] button once during playback.

The [A <> B] button flashes. This point becomes the starting point (A mark) for the playback loop.

\* After inserting the A mark, pressing the  (Stop) button before setting the B mark cancels the A mark.

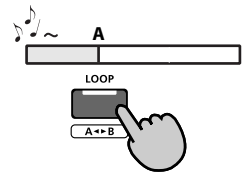

### 2. Press the [A <> B] button again.

The [A <> B] button lights up. This point becomes the end point (B mark) for the playback loop.

The section set in the steps 1 and 2 automatically plays back repeatedly.

\* After inserting the A mark, if you play back to the end of the file without setting the B mark, the end of file becomes the B mark.

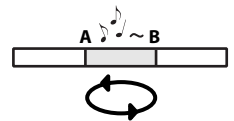
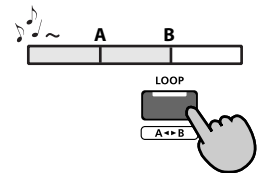

## Canceling the loop playback

To cancel the loop playback after inserting A and B marks, press the [A <> B] button.

The [A <> B] button turns off and the loop playback is cancelled.

## Using the metronome

**1. Press the [METRONOME] button.**

The metronome function is turned on and the [METRONOME] button flashes.

**2. The metronome setting screen is displayed.**

Use the [CURSOR/VALUE] knob to adjust the tempo, beat, and volume of the metronome.



Parameter	Description
Tempo	Tempo (BPM)
Beat	Beat
Level	Volume (0-127)

**3. Press the [WAVE RECORDER] button to return to the main screen.**

**4. To turn off the metronome, press the [METRONOME] button again.**

The light of the [METRONOME] button turns off.



## Recording while playing back a file

You can play back a file in the background and record only your playing at the same time.

1. **Select the file to play back in the background (See p. 30).**
2. **Press and hold the [SHIFT] button, and press the [CURSOR/VALUE] knob.**

The main screen displays "BG" to the right of the file name. This indicates that the file is selected for background playback.



3. **Press the  (Record) button.**  
Recording starts. At the same time, the file selected for background playback starts.
4. **To finish recording, press the  (Stop) button.**
5. **When you start playback, the recorded file and the background file are played back simultaneously.**
6. **To cancel the selection of the background file, press and hold the [SHIFT] button and press the [CURSOR/VALUE] knob.**

**MEMO**

If the file for the background playback is selected, rewind and fast-forward operations affect both files.

**MEMO**

If the background file is longer than the file being recorded, the play button will blink when the recorded file has played to its end, and playback will continue to the end of the background file.

**MEMO**

To display the name of the file for background playback, press the [SHIFT] button.

## Deleting a file

**NOTE**

A deleted file cannot be recovered.

1. From the main screen, press the [CURSOR/VALUE] knob to access the finder screen (p. 26).
2. From the finder screen, turn the [CURSOR/VALUE] knob to select the file that you want to delete, and then press the [CURSOR/VALUE] knob.
3. Turn the [CURSOR/VALUE] knob to highlight “Delete,” and then press the [CURSOR/VALUE] knob.



4. A confirmation screen appears.

To delete the selected file, press the [CURSOR/VALUE] knob once again.

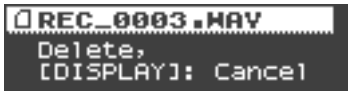

If you decide not to delete the file, press the [DISPLAY] button.

5. When the file has been deleted, you will return to the finder screen.

Press the [DISPLAY] button to return to the previous screen.

# Connections

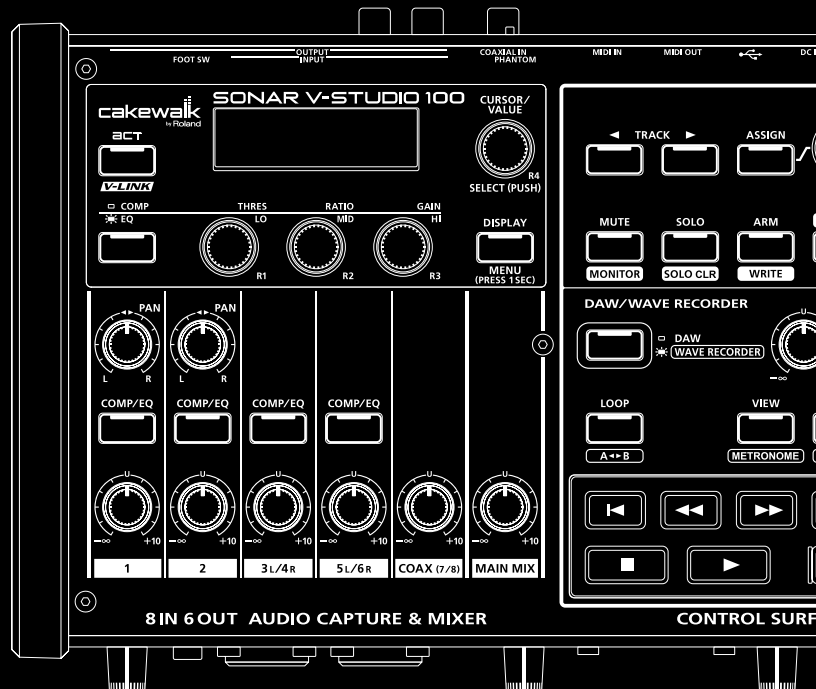

# Connections

## Connecting the AC adaptor

Connect the included AC adaptor to the SONAR V-STUDIO 100's DC IN jack.

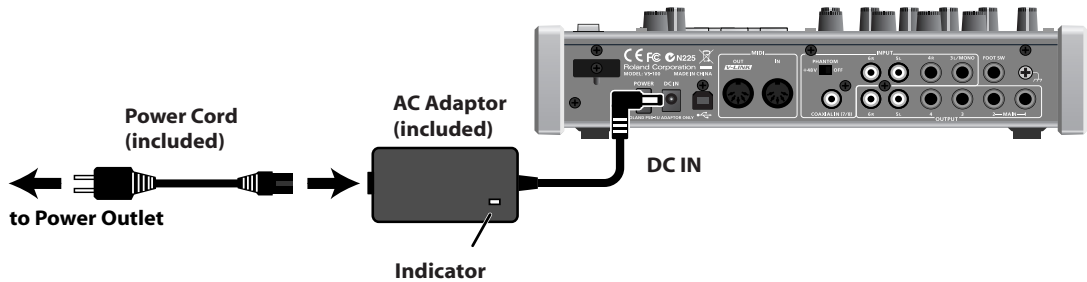

### NOTE

Place the AC adaptor so the side with the indicator (see illustration) faces upwards and the side with textual information faces downwards.

\* The indicator will light when you plug the AC adaptor into an AC outlet.

### NOTE

To prevent the inadvertent disruption of power to your unit (should the plug be pulled out accidentally), and to avoid applying undue stress to the AC adaptor jack, anchor the power cord using the cord hook, as shown in the illustration.

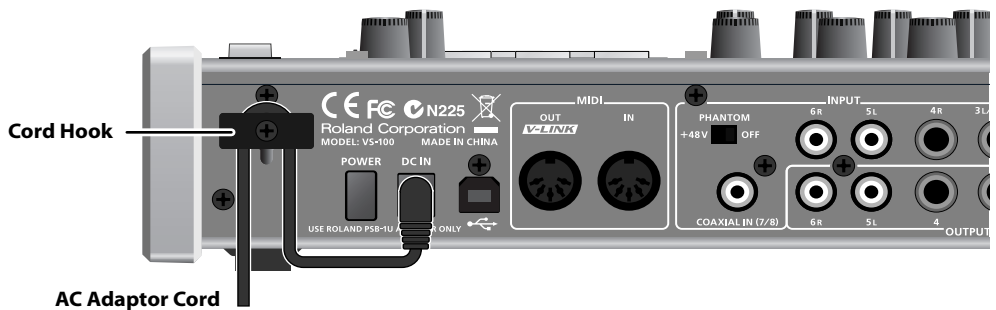

## Connecting computers and audio equipments

### NOTE

Before connecting the SONAR V-STUDIO 100 to a computer, read the separate Installation Guide and install the SONAR V-STUDIO 100 driver on the computer. If the driver is not installed, SONAR V-STUDIO 100 cannot be operated correctly from the computer.

- Use a USB cable to connect your computer to the SONAR V-STUDIO 100.
  - Connect your audio output devices such as headphones or speakers to the SONAR V-STUDIO 100.
- \* This package does not include audio output devices such as headphones or speakers.

### Headphones



### Monitor amplified speakers

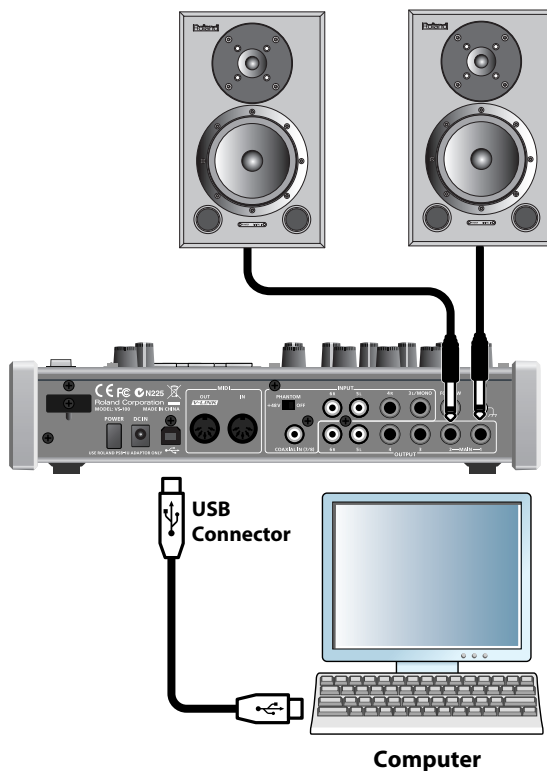

# Turning the power on

- \* Once the connections have been completed (p. 38), turn on power to your various devices in the order specified. By turning on devices in the wrong order, you risk causing malfunction and/or damage to speakers and other devices.
- \* This unit is equipped with a protection circuit. A brief interval (a few seconds) after power up is required before the unit will operate normally.
- \* Always make sure to have the volume level turned down before switching on power. Even with the volume all the way down, you may still hear some sound when the power is switched on, but this is normal, and does not indicate a malfunction.

## 1. Turn the SONAR V-STUDIO 100's [MAIN MIX] knob and the Headphone [VOLUME] knob to the minimum.

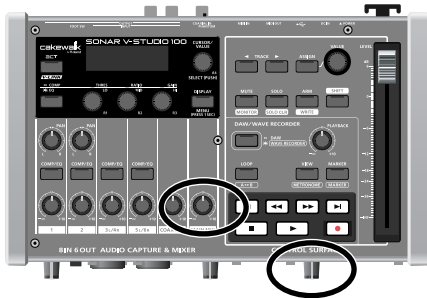

## 2. If the SONAR V-STUDIO 100 is connected to a computer, turn on the power of your computer.

## 3. Turn on the power switch of SONAR V-STUDIO 100.



## 4. Turn on the power of the monitor speaker.

- \* To protect its circuits, the SONAR V-STUDIO 100 does not operate for a while after you turn the power on.



# Connections and signal flow

## Connecting microphones and guitars

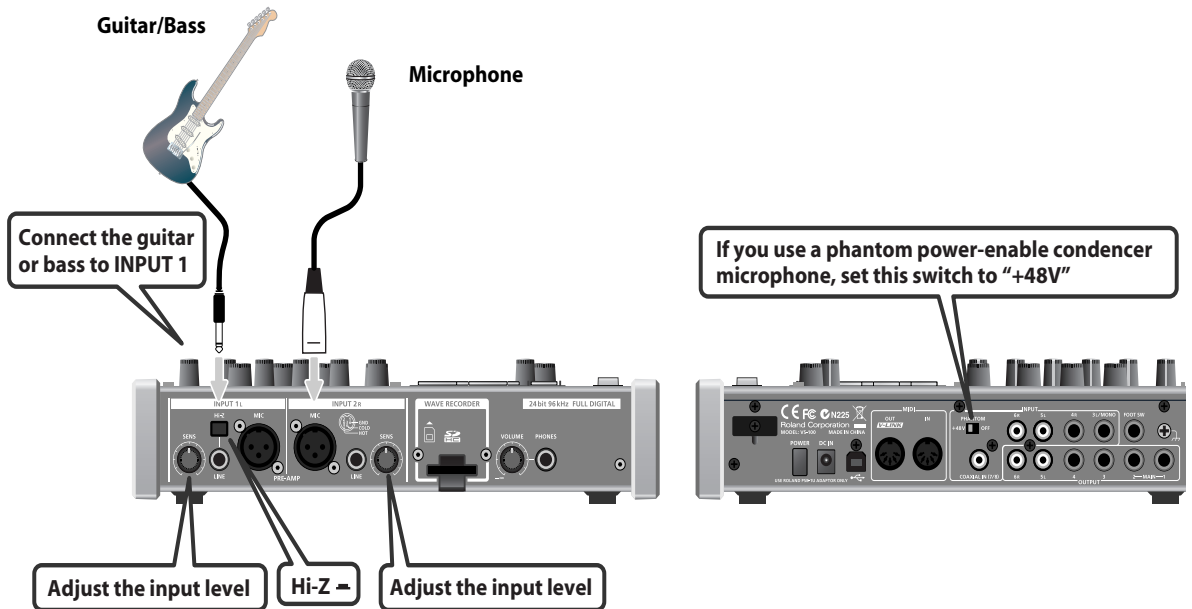

- \* To prevent malfunction and/or damage to speakers or other devices, always turn down the volume, and turn off the power on all devices before making any connections.
- \* When connection cables with resistors are used, the volume level of equipment connected to the INPUT connectors may be low. If this happens, use connection cables that do not contain resistors.
- \* Feedback could be produced depending on the location of microphones relative to speakers. This can be remedied by:
  1. Changing the orientation of the microphone(s).
  2. Relocating microphone(s) at a greater distance from speakers.
  3. Lowering volume levels.
- \* Do NOT connect anything to input terminals that you are not using.

### Adjusting the level

Use the [SENS] knob to adjust the input level. To achieve the best recording quality, display the level meter on the screen and use the [SENS] knob to increase the level as far as possible without the input level exceeding the normal level.

## Signal flow when recording with SONAR

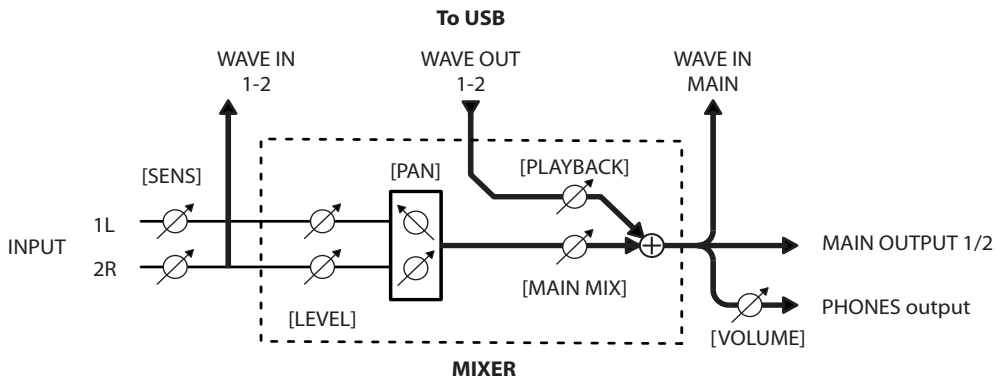

If you connect the SONAR V-STUDIO 100 to your computer with a USB cable, you can use SONAR to record sounds input to INPUT 1L/INPUT 2R.

\* The [PAN] knob does not have any effect on USB audio.

## Signal flow when recording with the WAVE recorder

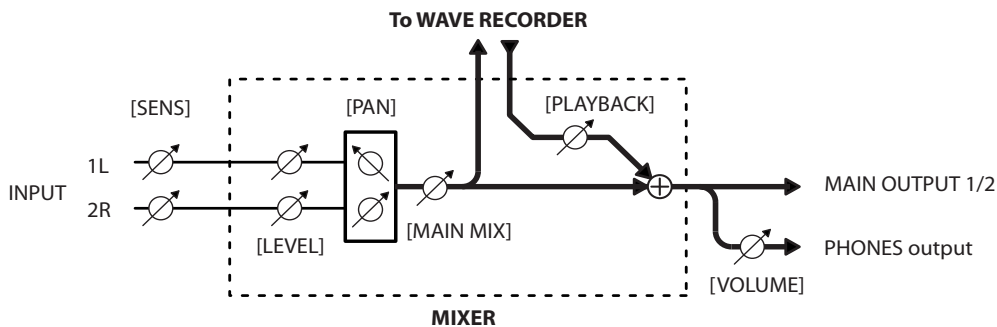

If the SONAR V-STUDIO 100 is not connected to a computer, the WAVE recorder function is available. Press the Record button to record sounds input to INPUT 1L/INPUT 2R.

To adjust the balance between the sounds input to INPUT 1L and INPUT 2R, use the [PAN] knob.

For more information about using the WAVE recorder function, see **“Using the WAVE recorder”** (p. 26).

## Connecting audio equipment and synthesizers

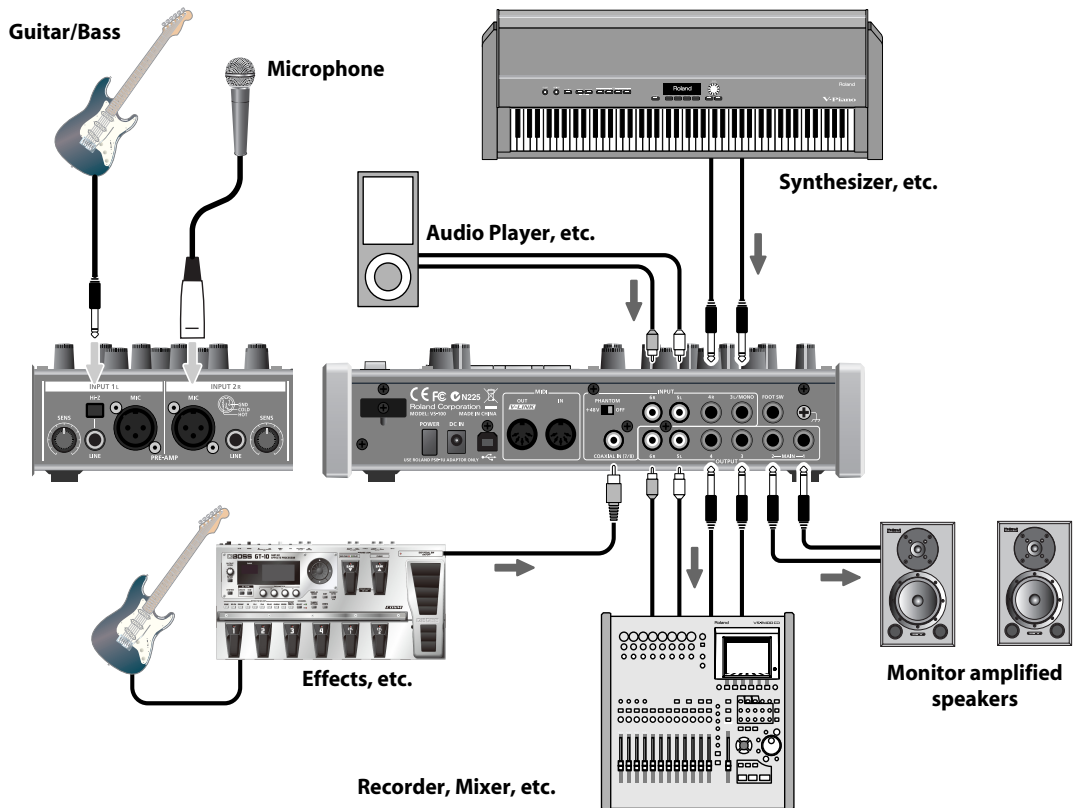

\* The sampling frequency of the input signal from digital equipment must be the same as that of the SONAR V-STUDIO 100. For more information about setting the sampling frequency of the SONAR V-STUDIO 100, see “**Sampling frequency setting**” (p. 52).

## Signal flow when recording with SONAR

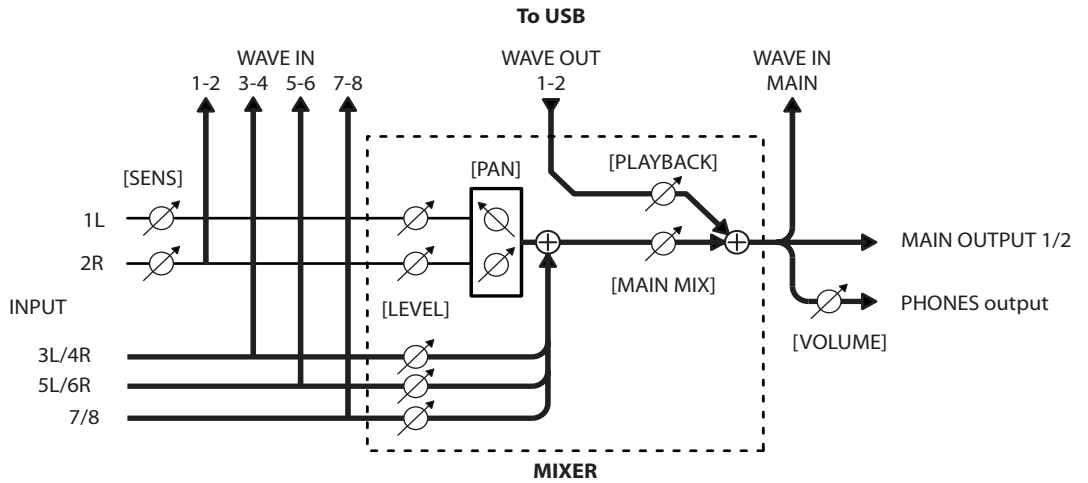

- To control the direct monitor volume for the input signal, use the [MAIN MIX] knob.
- To control the SONAR's playback volume, use the [PLAYBACK] knob.

## Signal flow when recording with the WAVE recorder

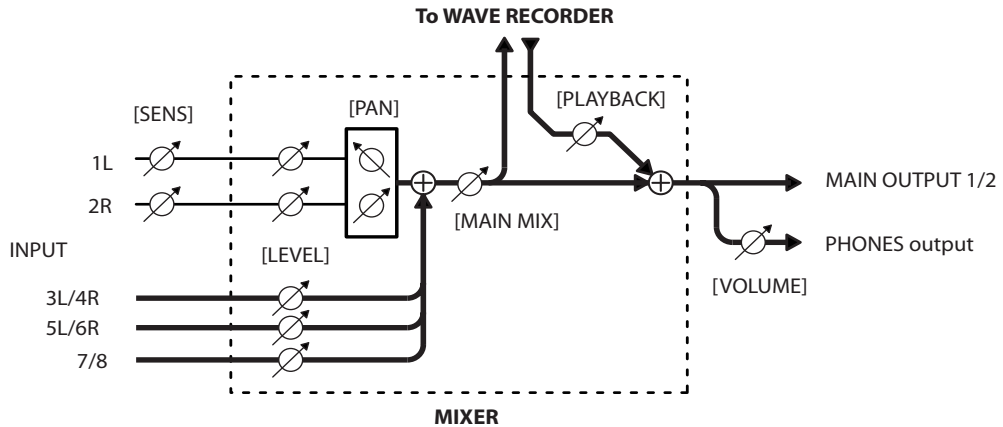

- Signals input to INPUT 1–8 are mixed and recorded on the WAVE recorder.
- To control the recording level of the WAVE recorder, use the [MAIN MIX] knob. The recording level can be checked with the level meter.
- To control the playback level of the WAVE recorder, use the [PLAYBACK] knob.
- If you change the system setting “WAV-Rec Source,” you can also use the WAVE recorder to record only the signals input to INPUT 1L/INPUT 2R. For more information, see “**Parameter list**” (p. 55).

# Connecting footswitches

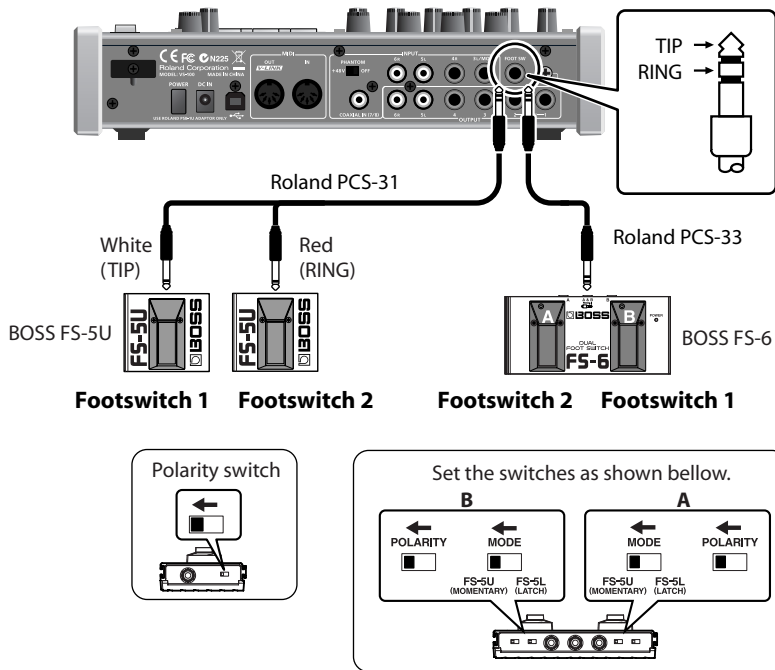

You can use footswitches to control the actions of the WAVE recorder and SONAR.

	Function
Footswitch 1	Playback
Footswitch 2	Recording

**MEMO**

If you are using SONAR, you can assign functions to footswitches in the VS-100 properties page (See p. 24).

# Compressor and Equalizer

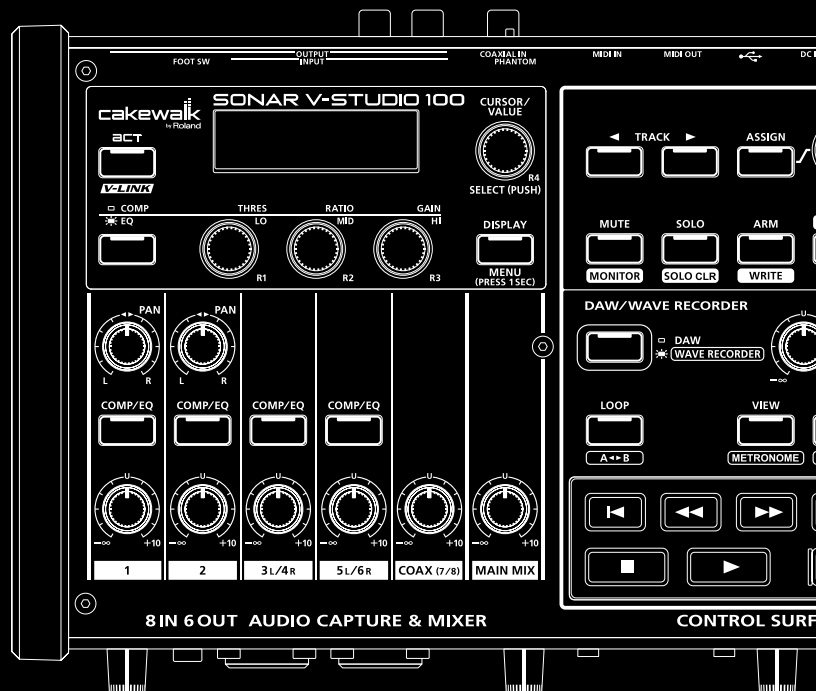

# Using the compressors and equalizers

Each analog input on SONAR V-STUDIO 100 is equipped with a compressor and a 3-band equalizer.

## Turning on the compressors and equalizers



When you press the [COMP/EQ] button on each channel, that channel's compressor and equalizer are turned on.

- When the compressor and equalizer are on, the [COMP/EQ] button is lit.
- The equalizer setting screen is displayed.
- When you press the [COMP/EQ] button of another channel, the equalizer setting screen for that channel is displayed.

## Turning off the compressors and equalizers

When you press the [COMP/EQ] button of a channel, the equalizer setting screen for that channel is displayed.

When you press the [COMP/EQ] button again, its compressor and equalizer are turned off.

The equalizer setting screen indicates that the compressor and equalizer have been turned off.





## Setting the compressors and equalizers

Equalizer setting screen

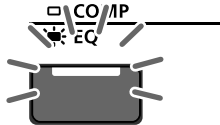

Compressor setting screen

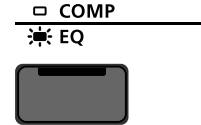

Pressing the compressor/equalizer toggle button switches between the screens for the compressor and the equalizer.

## Setting the equalizers

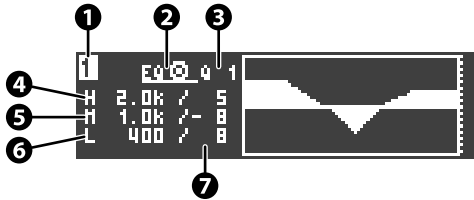

	Meaning	Changing the settings
1	Channel currently displayed	Press the [COMP/EQ] button for each channel
2	Equalizer bypass	Use the [CURSOR/VALUE] knob to set the cursor, and then press the knob
3	Equalizer Q	
4	Hi band cutoff frequency/gain	1. Use the [CURSOR/VALUE] knob to set the cursor
5	MID band center frequency/gain	2. Press the [CURSOR/VALUE] knob
6	LO band cutoff frequency/gain	3. Use the [CURSOR/VALUE] knob to change the value
		4. Press the [CURSOR/VALUE] knob to confirm
7	Gain of each band	Adjust each of the [LO], [MID] and [HI] knobs

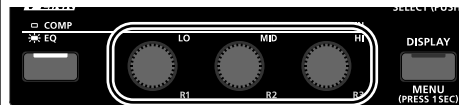

\* The HI and LO bands are shelving type and the MID band is peaking type.

## Setting the compressors

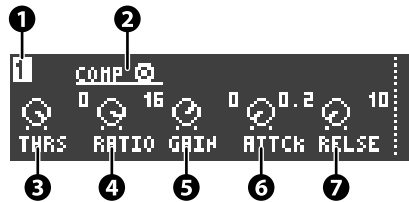

	Meaning	Changing the settings
1	Channel currently displayed	Press the [COMP/EQ] button for each channel
2	Compressor bypass	Use the [CURSOR/VALUE] knob to set the cursor, and then press the knob
3	Threshold	Adjust each of the [THRES], [RATIO] and [GAIN] knobs
4	Compression ratio	
5	Output gain	
6	Attack time	
7	Release time	<ol style="list-style-type: none"> <li>1. Use the [CURSOR/VALUE] knob to set the cursor</li> <li>2. Press the [CURSOR/VALUE] knob</li> <li>3. Use the [CURSOR/VALUE] knob to change the value</li> <li>4. Press the [CURSOR/VALUE] knob to confirm</li> </ol>

# Appendix

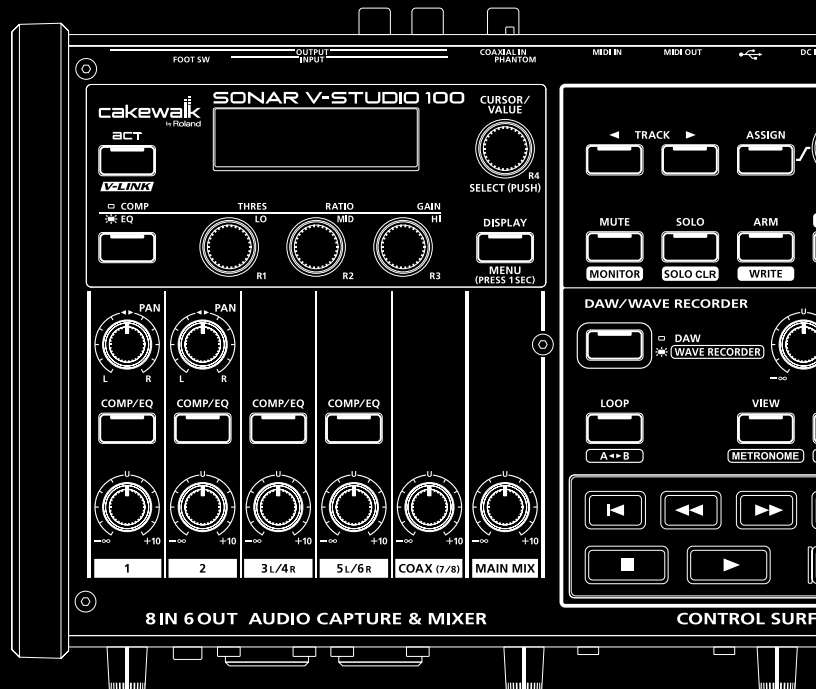

# System settings

## Formatting an SD memory card

An SD memory card that you have just purchased or an SD memory card that has been used by a computer or other device must be formatted as described below before it can be used with the SONAR V-STUDIO 100.

### NOTE

When you format an SD memory card, all data on that card will be erased. Be sure to back up any important data before you proceed.

### MEMO

If an SD memory card that is not in a state that can be used by the SONAR V-STUDIO 100 is inserted, the display will indicate "SD Unformatted."

1. Hold down the [DISPLAY] button for approximately one second to access the system setting screen.
2. Turn the [CURSOR/VALUE] knob to move the cursor to "SD Format," and then press the [CURSOR/VALUE] knob.



3. A confirmation screen appears.

To begin formatting, turn the [CURSOR/VALUE] knob to highlight "Yes," and then press the [CURSOR/VALUE] knob.



If you decide not to format the card, turn the [CURSOR/VALUE] knob to highlight "No," and then press the [CURSOR/VALUE] knob.

\* Do not remove the SD memory card until formatting has been completed.

4. When formatting has been completed, you will return to the system setting screen.

5. Press the [DISPLAY] button to return to the previous screen.

## Sampling frequency setting

If you want to connect the SONAR V-STUDIO 100 to your computer via USB and use its USB audio interface functionality, set the V-STUDIO's sampling frequency to match your software's sampling frequency as follows.

1. Hold down the [DISPLAY] button for approximately one second to access the system setting screen.
2. Turn the [CURSOR/VALUE] knob to move the cursor to "Sample Freq," and then press the [CURSOR/VALUE] knob.



3. Turn the [CURSOR/VALUE] knob to specify the desired sampling frequency, and then press the [CURSOR/VALUE] knob to confirm the change.



4. Turn the SONAR V-STUDIO 100's power off and then on again.

The SONAR V-STUDIO 100's sampling frequency setting will not change until the power has been turned off and on again.

### MEMO

If the SONAR V-STUDIO 100's actual sampling frequency does not match the setting in the system setting screen, an "\*" symbol is shown by the sampling frequency value.

## Reverb settings

The digital mixer section provides reverb that can be applied to the signal from each input.

When you execute the system setting “Reverb” (p. 55), the reverb screen appears, allowing you to specify the reverb type and adjust the send levels for each input.



Parameter	Value
Type	ECHO, ROOM, SMALL HALL, LARGE HALL
SEND LEVEL	Adjust the amount of reverb applied to each channel

### MEMO

If reverb is on, the “Rv” icon is shown at the left of the level meter screen. If reverb is being applied to a channel, that channel number will be highlighted.



## Initialization

### Initializing the settings

To initialize the settings to their factory-set state, proceed as follows.

### MEMO

The LCD contrast, sampling frequency, digital input settings, and the data in the SD memory card will not be initialized.

1. Hold down the [DISPLAY] button for approximately one second to access the system setting screen.
2. Turn the [CURSOR/VALUE] knob to move the cursor to “Initialize,” and then press the [CURSOR/VALUE] knob.

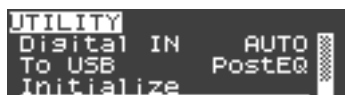

3. A confirmation screen appears.

To execute initialization, turn the [CURSOR/VALUE] knob to highlight “Yes,” and then press the [CURSOR/VALUE] knob.

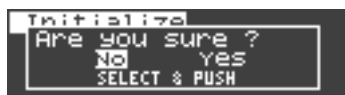

If you decide not to initialize, turn the [CURSOR/VALUE] knob to highlight “No,” and then press the [CURSOR/VALUE] knob.

4. When initialization is completed, you will return to the system setting screen.
5. Press the [DISPLAY] button to return to the previous screen.

## Initializing the system settings (Factory Reset)

To initialize all settings of SONAR V-STUDIO 100 to their factory-set state, proceed as follows.

### MEMO

The data in the SD memory card will not be initialized.

1. Power-off the SONAR V-STUDIO 100.
2. While holding down the [ACT]/[V-LINK] button and the compressor/equalizer setting button, power-on the SONAR V-STUDIO 100.



3. When the screen indicates "Factory Reset," release the [ACT]/[V-LINK] button and the compressor/equalizer setting button.

## Other settings

The system setting screen lets you change various settings to specify how the SONAR V-STUDIO 100 will operate.

### Operations in the system setting screen

1. Hold down the [DISPLAY] button for approximately one second; the system setting (UTILITY) screen appears.
2. Turn the [CURSOR/VALUE] knob to move the cursor to the parameter that you want to change.



3. Press the [CURSOR/VALUE] knob to highlight the value of that parameter.



4. Turn the [CURSOR/VALUE] knob to change the value.
5. Press the [CURSOR/VALUE] knob to confirm the change.
6. Press the [DISPLAY] button to return to the previous screen.

## Parameter list

Parameter	Description	Value
LCD Contrast	Adjusts the contrast of the display. Higher values will make the display appear darker.	0–19
Sample Freq	Specifies the sampling frequency of the SONAR V-STUDIO 100. For details, refer to “ <b>Sampling frequency setting</b> ” (p. 52).	44.1, 48.0, 96.0 (kHz)
Reverb	Accesses the setting screen for the built-in reverb. For details, refer to “ <b>Reverb settings</b> ” (p. 53).	–
WAV-Play Mode	Specifies the file playback mode for the WAVE recorder. <b>Sgl:</b> Play only the selected file. <b>Seq:</b> When the selected file finishes playing, play the next file.	Sgl, Seq
WAV-Play Rept	Turns repeat playback on/off for files in the WAVE recorder.	OFF, ON
WAV-Play Mon	Specifies whether file playback in the WAVE recorder will be stereo or mono.	ST, MONO
WAV-Rec Source	Specifies the source when recording into the WAVE recorder. <b>Mix:</b> Record the mixed signal of INPUT 1–8. <b>1-2:</b> Record only INPUT 1/2. The INPUT 1 signal will be recorded on the left channel, and the INPUT 2 signal will be recorded on the right channel. To play back a file that was recorded with these settings, set WAV-Play Mon to MONO. For details on routing, refer to the block diagram (p. 56).	Mix, 1-2
WAV-Rec Bit	Specifies the bit depth when recording into the WAVE recorder. In order to play back a file that was recorded at 24-bit or 32-bit depth, you must use a media player software that supports those bit depths.	16, 24, 32 (bit)
DAW Select	Specifies the operating mode of the control surface section. Normally you should leave this set to SONAR. If you’re using a DAW other than SONAR, set this to Other. For details, refer to “ <b>Using DAW software other than SONAR</b> ” (p. 24).	Sonar, Other
DAW Full Asgn	Allows the knobs and buttons of the digital mixer section to be used as controllers of the ACT section. For details, refer to “ <b>ACT section</b> ” (p. 23).	OFF, ON
Storage	If this is ON, the SD card slot can be used as a USB mass storage device when connected to a computer. When this is ON, the USB audio/MIDI interface functionality cannot be used. * Change this setting while the SONAR V-STUDIO 100 is not USB-connected to a computer.	OFF, ON
SD Format	Formats (initializes) the SD card in the SD card slot. For the procedure, refer to “ <b>Formatting an SD memory card</b> ” (p. 52).	–
Digital IN	Turns the INPUT 7-8 (COAXIAL IN) input on/off. <b>AUTO:</b> The input signal from INPUT 7-8 (COAXIAL IN) will be received. The SONAR V-STUDIO 100 will switch to the same sampling frequency as this digital signal. <b>OFF:</b> The digital signal will not be received.	AUTO, OFF
To USB	Specifies the signal that is sent to the USB audio input (recording). <b>Post EQ:</b> The signal processed by the internal compressor/equalizer will be sent. <b>Pre EQ:</b> The signal will be sent before being processed by the internal compressor/equalizer.	Post EQ, Pre EQ
Initialize	Initializes SONAR V-STUDIO 100 settings. For details, refer to “ <b>Initialization</b> ” (p. 53).	–

# Block Diagram

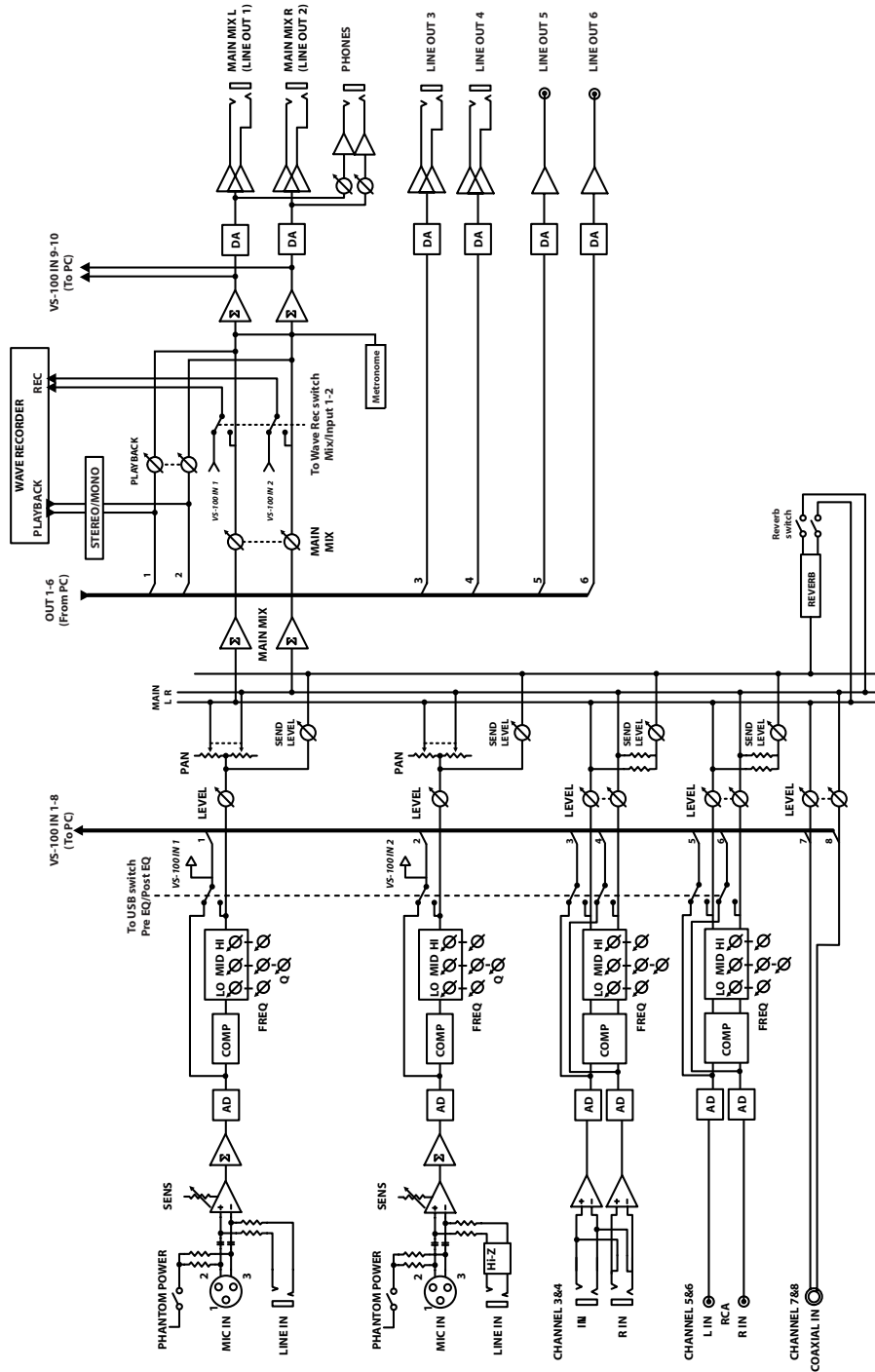



# About V-LINK

## What is V-LINK?

V-LINK ( **V-LINK** ) is functionality that allows you to perform music and video simultaneously. By connecting V-LINK compatible devices via MIDI, you can easily enjoy a variety of video effects that are linked with your performance. For example, by using the SONAR V-STUDIO 100 in conjunction with the EDIROL Visual Sampler P-10, you can enjoy performing synchronized video from the SONAR V-STUDIO 100.

### MEMO

In order to enjoy V-LINK between the SONAR V-STUDIO 100 and EDIROL P-10, you'll need MIDI cables (sold separately) to make connections.

## Turning V-LINK on/off

1. Power-on the SONAR V-STUDIO 100 with it disconnected from your computer.

### MEMO

You can't use the V-LINK frequency when connected to a computer via USB.

2. Press the [V-LINK] button to make it light.

V-LINK will turn on, and the "V" icon appears in the left side of the level meter screen.

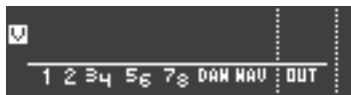

When V-LINK is on, you'll be able to control the video image from the control surface section.

3. Press [V-LINK] button once again to turn V-LINK off.

The V-LINK button will go dark.

## Connection example

This explanation uses the example of a connection with the EDIROL P-10. Use a MIDI cable to connect the SONAR V-STUDIO 100's MIDI OUT connector to the EDIROL P-10's MIDI IN connector.



### NOTE

To avoid malfunctions or speaker damage, lower the volume of all device and turn off their power before you make connections.

## V-LINK parameters

Controller	V-LINK Control	Transmitted MIDI Message
TRACK <	Image Switching (Clip Switching)	C0 00
TRACK >		C0 01
ASSIGN		C0 02
MUTE		C0 03
SOLO		C0 04
ARM		C0 05
VALUE	Video Control, Video Bank Select	B0 00 00-47
Fader	Video Control	B0 0B 00-7F
V-LINK	Mode Switching	(*1)

\*1: Differs depending on whether the power is on or off  
 ON: F0H 41H 10H 00H 51H 12H 10H 00H 00H 01H 6FH F7H  
 OFF: F0H 41H 10H 00H 51H 12H 10H 00H 00H 00H 70H F7H

# Error Message List

## SD Card Slow/Push Any Key



Recording into the WAVE recorder was halted because writing to the SD memory card was not fast enough.

Press any button to clear this message.

### Action:

- Try formatting the SD memory card (p. 52).
- Try recording at a lower sampling frequency or lower bit depth (p. 55).
- If the error still appears, try using a different SD memory card.

## SD Unformatted



The WAVE recorder cannot record or play back because an unrecognizable SD card is inserted.

### Action:

- Try formatting the SD memory card (p. 52).
- If the error still appears, try using a different SD memory card.

## SD Card Full

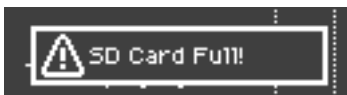

Recording into the WAVE recorder was halted because the SD memory card has insufficient free space.

### Action:

- Delete unneeded files or move files to your computer to increase the amount of free space on the SD memory card.
- Use a different SD memory card.

## SD Card Locked

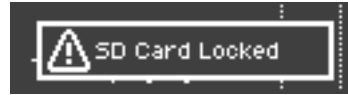

The WAVE recorder cannot record because the SD memory card is set to the Lock state (write protect).

### Action:

- Refer to the owner's manual of your SD memory card, and defeat the Lock setting to make the card writable.

## SD Card Error!

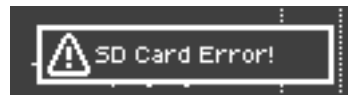

An error occurred while accessing the SD memory card.

### Action:

- Try formatting the SD memory card (p. 52).
- If the error still appears, try using a different SD memory card.

## File-Sys Error



The WAVE recorder cannot record or play back because an unrecognizable SD card is inserted.

### Action:

- Try formatting the SD memory card (p. 52).
- If the error still appears, try using a different SD memory card.

## Improper File



The selected file cannot be played by the SONAR V-STUDIO 100.

### Action:

- Use SONAR or other software to convert the file to a format that can be played by the SONAR V-STUDIO 100.

**cf.** →

For more information about playable formats, see “**Specifications**” (p. 60).

## Recorder Working



The operation cannot be executed because the WAVE recorder is recording.

### Action:

- Stop recording on the WAVE recorder, and perform the operation once again.

## Files Frequency Mismatch



The selected file cannot be played because it does not match the sampling frequency of the background file.

### Action:

- Select a file whose sampling frequency matches. (To check a file's sampling frequency, see “**Viewing file information**” (p. 31))
- Use SONAR or other software to convert the file's sampling frequency.

## Coaxial Frequency Mismatch



The selected file cannot be played because it does not match the sampling frequency of the digital signal being input to INPUT 7-8 (COAXIAL IN).

### Action:

- Select a file whose sampling frequency matches. (To check a file's sampling frequency, see “**Viewing file information**” (p. 31))
- Change the digital signal's sampling frequency to match the file.
- Turn off the digital input (p. 55).

## Coaxial In Error/Unsupported Clock



A digital signal of a sampling frequency not supported by the SONAR V-STUDIO 100 is being input to INPUT 7-8 (COAXIAL IN).

### Action:

- Switch your external digital device to a sampling frequency that is supported by the SONAR V-STUDIO 100, or switch the V-STUDIO's sampling frequency to match that of the digital input signal.
- If the V-STUDIO is connected via USB, match the sampling frequency of your digital device to the sampling frequency of the V-STUDIO and your software.

# Specifications

## Digital Audio Workstation: SONAR V-STUDIO 100

Audio Interface, Mixer	
Number of Input Channels	8
AD/DA Conversion	Sample Rate: 44.1/48.0/96.0 kHz Signal Processing: 24 bits
DSP processing	Compressor: Input Jacks 1–6 Equalizer: Input Jacks 1–6 Reverb: Input Jacks 1–6 (Echo/Room/Small Hall/Large Hall) Internal: 40 bits
Number of USB Audio Record/ Playback Channels	Record: 10 channels Playback: 6 channels (Full duplex)
Frequency Response	96.0 kHz: 20 Hz to 40 kHz (+0/-3 dB) 48.0 kHz: 20 Hz to 22 kHz (+0/-3 dB) 44.1 kHz: 20 Hz to 20 kHz (+0/-3 dB)
Residual Noise Level (IHF-A, typ.)	- 81 dBu (MAIN MIX knob = U, CHANNEL VOLUME knobs = U)
Dynamic Range	AD block: Input Jacks 1–2: 104 dB typ. (GAIN: min.) Input Jacks 3–6: 100 dB typ. DA block: Output Jack 1–2: 112 dB typ. Output Jack 3–6: 106 dB typ.
Nominal Input Level:	Mic Input Jacks 1–2: -60 to -16 dBu Input Jacks 1–2: -40 to +4 dBu Input Jacks 3–4: +4 dBu Input Jacks 5–6: -10 dBu * Maximum input level: Nominal input level + 18 dB
Input Impedance	Mic Input Jacks 1–2: 1.5 k ohms Input Jacks 1–4: 15 k ohms Input Jacks 2 (Hi-Z): 500 k ohms Input Jacks 5–6: 18 k ohms
Nominal Output Level	Output Jack 1–4: +4 dBu Output Jack 5–6: -10 dBu * Maximum output level: Nominal Output Level + 18 dB
Output Impedance	Output Jack 1–4: 2 k ohms Output Jack 5–6: 1 k ohms
Recommended Load Impedance	10 k ohms or greater
Connectors	Mic Input Jacks 1–2: XLR type (balanced/phantom power +48 V) Output Jacks 1–4: 1/4 inch TRS phone type (balanced) Output Jacks 5–6: RCA pin type MIDI Connectors (Input/Output) Digital Input Connector: Coaxial type USB Connector (B type) Headphones Jack: Stereo 1/4 inch phone type

<b>Control Surface</b>	
TRACK Control	100mm Touch-sensitive Motorized Fader Assignable Encoder Assign Button Track Select Button: +/- Track Control Button: MUTE/SOLO/ARM/SHIFT Track Control Button: LOOP/TRACK VIEW/MARKER Transport
ACT Control	ACT Button ACT Encoder:R1-R4
<b>WAVE RECORDER</b>	
* WAVE RECORDER does not function when VS-100 is connected to a computer via USB.	
Channels	Record: Stereo 1 channel Playback: Stereo 1 channel (NORMAL MODE) Playback: Stereo 2 channel (REC-ON-PLAY MODE)
Data Type	Format: STEREO, WAV Sampling Frequency: 44.1 kHz/48.0 kHz/96.0 kHz Bit Depth: 16/24/32-bit
Recording Media	SD(HC) memory card, 512M Byte or more
Files	Up to 2 GB: 512 files 4 GB or more: 1000 files
Controls	A-B REPEAT Metronome Marker REC-ON-PLAY MODE
Recording Time using 8GB SDHC card	16 bit/44.1 k Hz stereo: 755 minutes 16 bit/48.0 k Hz stereo: 694 minutes 24 bit/48.0 k Hz stereo: 462 minutes 24 bit/96.0 k Hz stereo: 231 minutes * Recording times are approximate. Actual results may vary somewhat. * If more than one recorded file exists, the total recordable time will be less than listed.
<b>OTHERS</b>	
Power Supply	DC 9 V (AC adaptor)
Current Draw	1 A
Phantom Power	+48 V/5 mA (each input)
Dimensions	282.0 (W) x 180.8 (D) x 70.2 (H) mm 11-1/8 (W) x 7-1/8 (D) x 2-13/16 (H) inches
Weight	1.9 kg/4 lbs 4 oz
Options	Foot Switch: BOSS FS-5U Dual Foot Switch: BOSS FS-6

\* 0 dBu = 0.775 Vrms

\* In the interest of product improvement, the specifications and/or appearance of this unit are subject to change without prior notice.

# Index

## A

AB button .....	27
AC adaptor .....	38
ACT button .....	18, 23
Active Controller Technology .....	23
Analog Input .....	14, 16
ARM button .....	21
ASSIGN button .....	20

## B

Background file .....	35
Beat .....	34

## C

Channel fader .....	21
Coaxial Frequency Mismatch .....	59
Coaxial In Error/Unsupported Clock .....	59
COMP/EQ button .....	17
Compressor .....	48, 50
Connection .....	41
Connector	
Footswitch .....	15
MIDI .....	15
USB .....	15
Control surface screen .....	19
Cord hook .....	15
CURSOR/VALUE knob .....	18

## D

DAW Full Asgn .....	23, 55
DAW Select .....	55
DAW/WAVE RECORDER button .....	26
DC IN jack .....	15
Delete	
File .....	36
Digital IN .....	55
DISPLAY button .....	18

## E

Equalizer .....	48–49
-----------------	-------

## F

Fader .....	21
Fast-forward button .....	22, 27
File	
Delete .....	36
Information .....	31
Select .....	30
File length .....	27
File name .....	27
Files Frequency Mismatch .....	59
File-Sys Error .....	58
Finder screen .....	26
Footswitch .....	46
Footswitch connector .....	15

## G

GAIN knob .....	18
Go beginning button .....	22
Go end button .....	22
Grounding terminal .....	15

## H

Headphone .....	14
HI knob .....	18
Hi-Z button .....	14

## I

Improper File .....	59
Information	
File .....	31
Initialize .....	53, 55
INPUT .....	14
Input	
1/4" balanced .....	16
Coaxial digital .....	16
Guitar/Bass .....	14
Microphone .....	14
RCA Pin .....	16

## L

LCD Contrast .....	55
Level .....	34
Level knob .....	17
Level meter .....	27
Level meter screen .....	18
LO knob .....	18
LOOP button .....	22
Loop playback .....	33

## M

Mackie Control .....	24
MAIN MIX knob .....	17
MAIN OUTPUT .....	16
Main screen .....	26
Marker .....	32
MARKER button .....	22, 27
Marker view .....	27
Metronome .....	34
METRANOME button .....	27
Microphone Preamp .....	14
MID knob .....	18
MIDI connector .....	15
MUTE button .....	21

## N

Next marker button .....	22
Next measure button .....	22

## O

Output	
1/4" TRS balanced .....	16
Headphone .....	14
Main output .....	16
RCA Pin .....	16

- P**
- PAN knob ..... 17
  - Phantom Power ..... 14, 16
  - Play button ..... 22, 27
  - Playback
    - Loop ..... 33
  - Playback button ..... 30
  - PLAYBACK knob ..... 16
  - Power switch ..... 15, 40
  - Previous marker button ..... 22
  - Previous measure button ..... 22
- R**
- R1 knob ..... 18
  - R2 knob ..... 18
  - R3 knob ..... 18
  - R4 knob ..... 18
  - RATIO knob ..... 18
  - RCA pin input ..... 16
  - Record button ..... 22, 27
  - Recorder Working ..... 59
  - Recording ..... 29
  - repeat A-B button ..... 27
  - Reverb ..... 53, 55
  - Rewind button ..... 22, 27
- S**
- Sample Freq ..... 55
  - Sampling frequency ..... 52
  - Screen
    - Control surface ..... 19
    - Finder ..... 26
    - Level meter ..... 18
    - Main (WAVE recorder) ..... 26
    - System setting ..... 54
    - UTILITY ..... 54
  - SD Card Error! ..... 58
  - SD Card Full ..... 58
  - SD Card Locked ..... 58
  - SD card slot ..... 14
  - SD Card Slow/Push Any Key ..... 58
  - SD Format ..... 55
  - SD memory card ..... 28
    - Format ..... 28, 52
    - Insert ..... 28
    - Remove ..... 28
  - SD Unformatted ..... 58
  - Select
    - File ..... 30
  - SENS knob ..... 14
  - SHIFT button ..... 21
  - Signal flow ..... 42, 44–45
  - SOLO button ..... 21
  - Stop button ..... 22, 27
  - Storage ..... 55
  - System setting screen ..... 54
- T**
- Tempo ..... 34
  - THRES knob ..... 18
  - Time counter ..... 27
  - To USB ..... 55
  - Track selection button ..... 20
  - TRS balanced input ..... 16
- U**
- USB connector ..... 15
  - UTILITY screen ..... 54
- V**
- VALUE knob ..... 20
  - VIEW button ..... 22
  - V-LINK ..... 57
  - V-LINK button ..... 18
  - VS-100 properties page ..... 24
- W**
- WAV-Play Mode ..... 55
  - WAV-Play Mon ..... 55
  - WAV-Play Rept ..... 55
  - WAV-Rec Bit ..... 55
  - WAV-Rec Source ..... 26, 55
- X**
- XLR Input ..... 14



For EU Countries

This product complies with the requirements of EMC Directive 2004/108/EC.

For the USA

## FEDERAL COMMUNICATIONS COMMISSION RADIO FREQUENCY INTERFERENCE STATEMENT

This equipment has been tested and found to comply with the limits for a Class B digital device, pursuant to Part 15 of the FCC Rules. These limits are designed to provide reasonable protection against harmful interference in a residential installation. This equipment generates, uses, and can radiate radio frequency energy and, if not installed and used in accordance with the instructions, may cause harmful interference to radio communications. However, there is no guarantee that interference will not occur in a particular installation. If this equipment does cause harmful interference to radio or television reception, which can be determined by turning the equipment off and on, the user is encouraged to try to correct the interference by one or more of the following measures:

- Reorient or relocate the receiving antenna.
- Increase the separation between the equipment and receiver.
- Connect the equipment into an outlet on a circuit different from that to which the receiver is connected.
- Consult the dealer or an experienced radio/TV technician for help.

This device complies with Part 15 of the FCC Rules. Operation is subject to the following two conditions:

- (1) this device may not cause harmful interference, and
- (2) this device must accept any interference received, including interference that may cause undesired operation.

Unauthorized changes or modification to this system can void the users authority to operate this equipment.  
This equipment requires shielded interface cables in order to meet FCC class B Limit.

For Canada

### NOTICE

This Class B digital apparatus meets all requirements of the Canadian Interference-Causing Equipment Regulations.

### AVIS

Cet appareil numérique de la classe B respecte toutes les exigences du Règlement sur le matériel brouilleur du Canada.

For C.A. US (Proposition 65)

### WARNING

This product contains chemicals known to cause cancer, birth defects and other reproductive harm, including lead.



For the U.K.

**IMPORTANT:** THE WIRES IN THIS MAINS LEAD ARE COLOURED IN ACCORDANCE WITH THE FOLLOWING CODE.

BLUE: NEUTRAL  
BROWN: LIVE

As the colours of the wires in the mains lead of this apparatus may not correspond with the coloured markings identifying the terminals in your plug, proceed as follows:

The wire which is coloured BLUE must be connected to the terminal which is marked with the letter N or coloured BLACK.  
The wire which is coloured BROWN must be connected to the terminal which is marked with the letter L or coloured RED.  
Under no circumstances must either of the above wires be connected to the earth terminal of a three pin plug.

For the USA

## DECLARATION OF CONFORMITY Compliance Information Statement

Model Name : VS-100  
Type of Equipment : Digital Audio Workstation  
Responsible Party : Cakewalk Inc.  
Address : 268 Summer Street, Boston, MA 02210  
Telephone : (617) 423-9004

### For EU Countries



- UK** This symbol indicates that in EU countries, this product must be collected separately from household waste, as defined in each region. Products bearing this symbol must not be discarded together with household waste.
- DE** Dieses Symbol bedeutet, dass dieses Produkt in EU-Ländern getrennt vom Hausmüll gesammelt werden muss gemäß den regionalen Bestimmungen. Mit diesem Symbol gekennzeichnete Produkte dürfen nicht zusammen mit den Hausmüll entsorgt werden.
- FR** Ce symbole indique que dans les pays de l'Union européenne, ce produit doit être collecté séparément des ordures ménagères selon les directives en vigueur dans chacun de ces pays. Les produits portant ce symbole ne doivent pas être mis au rebut avec les ordures ménagères.
- IT** Questo simbolo indica che nei paesi della Comunità europea questo prodotto deve essere smaltito separatamente dai normali rifiuti domestici, secondo la legislazione in vigore in ciascun paese. I prodotti che riportano questo simbolo non devono essere smaltiti insieme ai rifiuti domestici. Ai sensi dell'art. 13 del D.Lgs. 25 luglio 2005 n. 151.
- ES** Este símbolo indica que en los países de la Unión Europea este producto debe recogerse aparte de los residuos domésticos, tal como está regulado en cada zona. Los productos con este símbolo no se deben depositar con los residuos domésticos.
- PT** Este símbolo indica que nos países da UE, a recolha deste produto deverá ser feita separadamente do lixo doméstico, de acordo com os regulamentos de cada região. Os produtos que apresentem este símbolo não deverão ser eliminados juntamente com o lixo doméstico.
- NL** Dit symbool geeft aan dat in landen van de EU dit product gescheiden van huishoudelijk afval moet worden aangeboden, zoals bepaald per gemeente of regio. Producten die van dit symbool zijn voorzien, mogen niet samen met huishoudelijk afval worden verwijderd.
- DK** Dette symbol angiver, at i EU-lande skal dette produkt opsamlles adskilt fra husholdningsaffald, som defineret i hver enkelt region. Produkter med dette symbol må ikke smides ud sammen med husholdningsaffald.
- NO** Dette symbolet indikerer at produktet må behandles som spesialavfall i EU-land, iht. til retningslinjer for den enkelte regionen, og ikke kastes sammen med vanlig husholdningsavfall. Produkter som er merket med dette symbolet, må ikke kastes sammen med vanlig husholdningsavfall.

- SE** Symbolen anger att i EU-länder måste den här produkten kasseras separat från hushållsavfall, i enlighet med varje regions bestämmelser. Produkter med den här symbolen får inte kasseras tillsammans med hushållsavfall.
- FI** Tämä merkintä ilmaisee, että tuote on EU-maissa kerättävä erillään kotitalousjätteistä kunkin alueen voimassa olevien määräysten mukaisesti. Tällä merkinnällä varustettuja tuotteita ei saa hävittää kotitalousjätteiden mukana.
- HU** Ez a szimbólum azt jelenti, hogy az Európá Unióban ezt a terméket a háztartási hulladékot elkülönítve, az adott régióban érvényes szabályozás szerint kell gyűjteni. Az ezzel a szimbóllal ellátott termékeket nem szabad a háztartási hulladékok közé dobni.
- PL** Symbol oznacza, że zgodnie z regulacjami w odpowiednim regionie, w krajach UE produktu nie należy wyrzucać z odpadami domowymi. Produktów opatrzonych tym symbolem nie można utylizować razem z odpadami domowymi.
- CZ** Tento symbol udává, že v zemích EU musí být tento výrobek sbíráán odděleně od domácího odpadu, jak je určeno pro každý region. Výrobky nesoucí tento symbol se nesmí vyhazovat spolu s domácím odpadem.
- SK** Tento symbol vyjadruje, že v krajinách EÚ sa musí zber tohto produktu vykonávať oddelene od domového odpadu, podľa nariadení platných v konkrétnej krajine. Produkty s týmto symbolom sa nesmú vyhazovať spolu s domovým odpadom.
- EE** See sümbol näitab, et EL-i maades tuleb see toode olemprügist eraldi koguda, nii nagu on igas piirkonnas määratletud. Selle sümboliga märgitud tooteid ei tohi ära visata koos olmeprügiga.
- LT** Šis simbolis rodo, kad ES šalyse šis produktas turi būti surenkamas atskirai nuo buitinių atliekų, kaip nustatyta kiekviename regione. Šiuo simboliu paženklinoti produktai neturi būti išmetami kartu su buitinėmis atliekomis.
- LV** Šis simbols norāda, ka ES valstīs šo produktu jāievāc atsevišķi no mājsaimniecības atkritumiem, kā noteikts katrā reģionā. Produkta ar šo simbolu nedrīkst izmest kopā ar mājsaimniecības atkritumiem.
- SI** Ta simbol označuje, da je treba proizvod v državah EU zbirati ločeno od gospodinskih odpadkov, tako kot je določeno v vsaki regiji. Proizvoda s tem znakom ni dovoljeno odlagati skupaj z gospodinskimi odpadki.
- GR** Το σύμβολο αυτό υποδηλώνει ότι στις χώρες της Ε.Ε. το συγκεκριμένο προϊόν πρέπει να συλλέγεται χωριστά από τα υπόλοιπα οικιακά απορρίμματα, σύμφωνα με όσα προβλέπονται σε κάθε περιοχή. Τα προϊόντα που φέρουν το συγκεκριμένο σύμβολο δεν πρέπει να απορρίπτονται μαζί με τα οικιακά απορρίμματα.

## 有关产品中所含有害物质的说明

本资料就本公司产品中所含的特定有害物质及其安全性予以说明。

本资料适用于 2007 年 3 月 1 日以后本公司所制造的产品。

### 环保使用期限



此标志适用于在中国国内销售的电子信息产品，表示环保使用期限的年数。所谓环保使用期限是指在自制造日起的规定期限内，产品中所含的有害物质不致引起环境污染，不会对人身、财产造成严重的不良影响。

环保使用期限仅在遵照产品使用说明书，正确使用产品的条件下才有效。  
不当的使用，将会导致有害物质泄漏的危险。

### 产品中有毒有害物质或元素的名称及含量

部件名称	有毒有害物质或元素					
	铅(Pb)	汞(Hg)	镉(Cd)	六价铬(Cr(VI))	多溴联苯(PBB)	多溴二苯醚(PBDE)
外壳(壳体)	×	○	○	○	○	○
电子部件(印刷电路板等)	×	○	×	○	○	○
附件(电源线、交流适配器等)	×	○	○	○	○	○

○：表示该有毒有害物质在该部件所有均质材料中的含量均在 SJ/T11363-2006 标准规定的限量要求以下。  
×：表示该有毒有害物质至少在该部件的某一均质材料中的含量超出 SJ/T11363-2006 标准规定的限量要求。  
因根据现有的技术水平，还没有什么物质能够代替它。

## Information

When you need repair service, call your nearest EDIROL/Roland Service Center or authorized Cakewalk/EDIROL/Roland distributor in your country as shown below.



**U.S.A.**  
Cakewalk, Inc.  
268 Summer Street Boston, MA  
02210 U.S.A.  
(617) 423-9004  
<http://www.cakewalk.com/>



**EUROPE**  
EDIROL (Europe) Ltd.  
Studio 3.4 114 Power Road  
London W4 5PY  
U. K.  
TEL: +44 (0)20 8747 5949  
FAX: +44 (0)20 8747 5948  
<http://www.edirol.com/europe>

**Deutschland**  
TEL: 0700 33 47 65 20  
**Italia**  
TEL: 02 93778329

## Roland

### NORTH AMERICA

**CANADA**  
Roland Canada Ltd.  
(Head Office)  
5480 Parkwood Way  
Richmond B. C., V6V 2M4  
CANADA  
TEL: (604) 270 6626

**Roland Canada Ltd.**  
(Toronto Office)  
170 Admiral Boulevard  
Mississauga On L5T 2N6  
CANADA  
TEL: (905) 362 9707

### AFRICA

**SOUTH AFRICA**  
Paul Bothner(PTY)Ltd.  
Royal Cape Park, Unit 24  
Londonderry Road, Ottery 7800  
Cape Town, SOUTH AFRICA  
TEL: (021) 799 4900

### AUSTRALIA/ NEW ZEALAND

**AUSTRALIA/  
NEW ZEALAND**  
Roland Corporation  
Australia Pty., Ltd.  
38 Campbell Avenue  
Dee Why West, NSW 2099  
AUSTRALIA

For Australia  
Tel: (02) 9982 8266  
For New Zealand  
Tel: (09) 3098 715

### CENTRAL/LATIN AMERICA

**BRAZIL**  
Roland Brasil Ltda.  
Rua San Jose, 211 Parque  
Industrial San Jose  
Cotia - Sao Paulo - SP, BRAZIL  
TEL: (011) 4615 5666

### ASIA

**CHINA**  
Roland Shanghai Electronics  
Co., Ltd.  
5F, No.1500 Pingliang Road  
Shanghai 200990, CHINA  
TEL: (021) 5580-0800

**Roland Shanghai Electronics  
Co., Ltd.**  
(BEIJING OFFICE)  
10F, No.18 3 Section Anhuaxili  
Chaoyang District Beijing  
100011 CHINA  
TEL: (010) 6426-5050

**VIET NAM**  
VIET THUONG  
CORPORATION  
386 CACH MANG THANG  
TAM ST. DIST.3,  
HO CHI MINH CITY  
VIET NAM  
TEL: 9316540

**HONG KONG**  
Tom Lee Music Co., Ltd.  
Service Division  
22-32 Pun Shan Street, Tsuen  
Wan, New Territories,  
HONG KONG  
TEL: 2415 0911

**INDIA**  
Rivera Digitec (India) Pvt. Ltd.  
411, Nirman Kendra  
Mahalaxmi Flats Compound  
Off. Dr. Edwin Moses Road,  
Mumbai-400011, INDIA  
TEL: (022) 2493 9051

**INDONESIA**  
PT Citra IntiRama  
Jl. Cideng Timur No. 15J-15O  
Jakarta Pusat  
INDONESIA  
TEL: (021) 6324170

**KOREA**  
Cosmos Corporation  
1461-9, Seocho-Dong,  
Seocho Ku, Seoul, KOREA  
TEL: (02) 3486-8855

### MALAYSIA/ SINGAPORE

Roland Asia Pacific Sdn. Bhd.  
45-1, Block C2, Jalan PJU 1/39,  
Dataran Prima, 47301 Petaling  
Jaya, Selangor, MALAYSIA  
TEL: (03) 7805-3263

**PHILIPPINES**  
G.A. Yupango & Co. Inc.  
339 Gil J. Puyat Avenue  
Makati, Metro Manila 1200,  
PHILIPPINES  
TEL: (02) 899 9801

**TAIWAN**  
ROLAND TAIWAN  
ENTERPRISE CO., LTD.  
Room 5, 9fl. No. 112 Chung  
Shan N.Road Sec.2, Taipei,  
TAIWAN, R.O.C.  
TEL: (02) 2561 3339

**THAILAND**  
Theera Music Co., Ltd.  
100-108 Soi Verg  
Nakornkasem, New  
Road, Sumpantawongse,  
Bangkok 10100 THAILAND  
TEL: (02) 224-8821

### EUROPE

**BELGIUM/FRANCE/  
HOLLAND/  
LUXEMBOURG**  
Roland Central Europe N.V.  
Houtstraat 3, B-2280, Oevel  
(Westerlo) BELGIUM  
TEL: (014) 575811

**CROATIA**  
ART-CENTAR  
Degenova 3,  
HR - 10000 Zagreb  
TEL: (1) 466 8493

**CZECH REP.**  
CZECH REPUBLIC  
DISTRIBUTOR s.r.o  
Vocáárova 247/16  
CZ - 180 00 PRAHA 8,  
CZECH REP.  
TEL: (2) 830 20270

**DENMARK**  
Roland Scandinavia A/S  
Nordhavnsvej 7, Postbox 880,  
DK-2100 Copenhagen  
DENMARK  
TEL: 3916 6200

**FINLAND**  
Roland Scandinavia As, Filial  
Finland  
Elanontie 5  
FIN-01510 Vantaa, FINLAND  
TEL: (09) 68 24 020

**GREECE/CYPRUS**  
STOLLAS S.A.  
Music Sound Light  
155, New National Road  
Patras 26442, GREECE  
TEL: 2610 435400

**HUNGARY**  
Roland East Europe Ltd.  
Warehouse Area 'DEFO' Pk.83  
H-2046 Torokbalint,  
HUNGARY  
TEL: (23) 511011

**NORWAY**  
Roland Scandinavia Avd.  
Kontor Norge  
Lilleakerveien 2 Postboks 95  
Lilleaker N-0216 Oslo  
NORWAY  
TEL: 2273 0074

**POLAND**  
POLAND POLSKA SP. Z O.O.  
ul. Kty Grodziskie 16B  
03-289 Warszawa  
Tel/Fax: +48 22 678 9512  
TEL: (022) 678 9512

**PORTUGAL**  
Roland Iberia, S.L.  
Portugal Office  
Cais das Pedras, 8/9-1 Dto  
4050-465, Porto, PORTUGAL  
TEL: 22 608 00 60

**ROMANIA**  
FBS LINES  
Piata Libertatii 1,  
535500 Gheorgheni,  
ROMANIA  
TEL: (266) 364 609

**RUSSIA**  
MuTek  
Dorozhnaya ul.3,korp.6  
117 545 Moscow, RUSSIA  
TEL: (095) 981-4967

**SLOVAKIA**  
DAN Acoustic s.r.o.  
Povazská 18.  
SK - 940 01 Nové Zámky  
TEL: (035) 6424 330

**SPAIN**  
Roland Iberia, S.L.  
Paseo Garcia Faria, 33-35  
08005 Barcelona SPAIN  
TEL: 93 493 91 00

**SWEDEN**  
Roland Scandinavia A/S  
SWEDISH SALES OFFICE  
Danvik Center 28, 2 tr.  
S-131 30 Nacka SWEDEN  
TEL: (08) 702 00 20

**SWITZERLAND**  
Roland (Switzerland) AG  
Landstrasse 5, Postfach,  
CH-4452 Itingen,  
SWITZERLAND  
TEL: (061)975-9987

**UKRAINE**  
EURHYTHMICS Ltd.  
P.O.Box: 37-a,  
Nedecy Str. 30  
UA - 89600 Mukachevo,  
UKRAINE  
TEL: (03131) 414-40

### MIDDLE EAST

**ISRAEL**  
Halilit P. Greenspoon & Sons  
Ltd.  
8 Retzif Ha'alia Hashnia St.  
Tel-Aviv-Yafo ISRAEL  
TEL: (03) 6823666

**TURKEY**  
ZUHAL DIS TICARET S.A.  
Galip Dede Cad. No.37  
Beyoglu - Istanbul / TURKEY  
TEL: (0212) 249 85 10

**cakewalk**  
by Roland



\* 5 1 0 0 0 0 6 4 0 9 - 0 1 \*